



 Read this manual carefully before operating this vehicle.

OWNER'S MANUAL

**XT250**

**XT250Z**  
**XT250ZC**

LIT-11626-23-37

3C5-28199-12

EAU10042

**⚠ WARNING**

**The engine exhaust from this product contains chemicals known to the State of California to cause cancer, birth defects or other reproductive harm.**

YAMAHA

LIT-CALIF-65-01

**⚠ Read this manual carefully before operating this vehicle. This manual should stay with this vehicle if it is sold.**

Congratulations on your purchase of the Yamaha XT250Z/XT250ZC. This model is the result of Yamaha's vast experience in the production of fine sporting, touring, and pacesetter racing machines. It represents the high degree of craftsmanship and reliability that have made Yamaha a leader in these fields.

This manual will give you an understanding of the operation, inspection, and basic maintenance of this motorcycle. If you have any questions concerning the operation or maintenance of your motorcycle, please consult a Yamaha dealer.

The design and manufacture of this Yamaha motorcycle fully comply with the emissions standards for clean air applicable at the date of manufacture. Yamaha has met these standards without reducing the performance or economy of operation of the motorcycle. To maintain these high standards, it is important that you and your Yamaha dealer pay close attention to the recommended maintenance schedules and operating instructions contained within this manual.

Yamaha continually seeks advancements in product design and quality. Therefore, while this manual contains the most current product information available at the time of printing, there may be minor discrepancies between your motorcycle and this manual. If there is any question concerning this manual, please consult a Yamaha dealer.

 **WARNING**

---

**Please read this manual and the “YOU AND YOUR MOTORCYCLE: RIDING TIPS” booklet carefully before operating this motorcycle. Do not attempt to operate this motorcycle until you have attained adequate knowledge of its controls and operating features. Regular inspections and careful maintenance, along with good operating techniques, will help ensure that you safely enjoy the capabilities and reliability of this motorcycle.**



---

# IMPORTANT MANUAL INFORMATION

---

EAU10132

Particularly important information is distinguished in this manual by the following notations:

	<b>This is the safety alert symbol. It is used to alert you to potential personal injury hazards. Obey all safety messages that follow this symbol to avoid possible injury or death.</b>
 <b>WARNING</b>	<b>A WARNING indicates a hazardous situation which, if not avoided, could result in death or serious injury.</b>
<b>NOTICE</b>	<b>A NOTICE indicates special precautions that must be taken to avoid damage to the vehicle or other property.</b>
<b>TIP</b>	A TIP provides key information to make procedures easier or clearer.

# **IMPORTANT MANUAL INFORMATION**

---

EAU10193

**XT250Z/XT250ZC  
OWNER'S MANUAL  
©2009 by Yamaha Motor Corporation, U.S.A.  
1st edition, April 2009  
All rights reserved.  
Any reprinting or unauthorized use  
without the written permission of  
Yamaha Motor Corporation, U.S.A.  
is expressly prohibited.  
Printed in Japan.  
P/N LIT-11626-23-37**

# TABLE OF CONTENTS

---

<b>LOCATION OF IMPORTANT LABELS</b> .....	1-1	<b>FOR YOUR SAFETY – PRE-OPERATION CHECKS</b> .....	5-1	Checking the throttle cable free play .....	7-18
<b>SAFETY INFORMATION</b> .....	2-1	<b>OPERATION AND IMPORTANT RIDING POINTS</b> .....	6-1	Valve clearance .....	7-19
<b>DESCRIPTION</b> .....	3-1	Starting and warming up a cold engine .....	6-1	Tires .....	7-19
Left view .....	3-1	Starting a warm engine .....	6-2	Spoke wheels .....	7-21
Right view .....	3-2	Shifting .....	6-2	Adjusting the clutch lever free play .....	7-21
Controls and instruments.....	3-3	Engine break-in .....	6-4	Adjusting the brake lever free play .....	7-22
<b>INSTRUMENT AND CONTROL FUNCTIONS</b> .....	4-1	Parking .....	6-4	Adjusting the rear brake light switch .....	7-23
Main switch/steering lock .....	4-1	<b>PERIODIC MAINTENANCE AND ADJUSTMENT</b> .....	7-1	Checking the front and rear brake pads .....	7-23
Indicator lights .....	4-2	Owner’s tool kit .....	7-2	Checking the brake fluid level .....	7-24
Multi-function display .....	4-3	Periodic maintenance chart for the emission control system .....	7-3	Changing the brake fluid .....	7-25
Handlebar switches .....	4-4	General maintenance and lubrication chart .....	7-5	Drive chain slack .....	7-25
Clutch lever .....	4-5	Removing and installing the cowling and panels .....	7-9	Cleaning and lubricating the drive chain .....	7-26
Shift pedal .....	4-5	Checking the spark plug .....	7-11	Checking and lubricating the cables .....	7-27
Brake lever .....	4-6	Canister (for California only) .....	7-13	Checking and lubricating the throttle grip and cable .....	7-27
Brake pedal .....	4-6	Engine oil and oil filter element .....	7-13	Checking and lubricating the brake and shift pedals .....	7-27
Fuel tank cap .....	4-6	Replacing the air filter element and cleaning the check hose .....	7-16	Checking and lubricating the brake and clutch levers .....	7-28
Fuel .....	4-7	Cleaning the spark arrester .....	7-17	Checking and lubricating the sidestand .....	7-29
Fuel cock .....	4-8	Carburetor .....	7-18	Lubricating the rear suspension .....	7-29
Starter (choke) knob “ > ” .....	4-9	Checking the engine idling speed .....	7-18	Checking the front fork .....	7-29
Seat .....	4-10				
Helmet holder .....	4-10				
Adjusting the shock absorber assembly .....	4-11				
Sidestand .....	4-12				
Ignition circuit cut-off system .....	4-13				

# TABLE OF CONTENTS

Checking the steering .....	7-30
Checking the wheel bearings .....	7-30
Battery .....	7-31
Replacing the fuse .....	7-32
Replacing the headlight bulb .....	7-33
Replacing the tail/brake light bulb .....	7-34
Replacing a turn signal light bulb .....	7-35
Supporting the motorcycle .....	7-35
Front wheel .....	7-36
Rear wheel .....	7-37
Troubleshooting .....	7-38
Troubleshooting chart .....	7-40

YAMAHA MOTOR CORPORATION, U.S.A. STREET AND ENDURO MOTORCYCLE LIMITED WARRANTY .....	10-7
YAMAHA EXTENDED SERVICE (Y.E.S.) .....	10-10

## **MOTORCYCLE CARE AND**

<b>STORAGE</b> .....	8-1
Matte color caution .....	8-1
Care .....	8-1
Storage .....	8-3

## **SPECIFICATIONS** .....

9-1

<b>CONSUMER INFORMATION</b> .....	10-1
Identification numbers .....	10-1
Reporting safety defects .....	10-3
Motorcycle noise regulation .....	10-4
Maintenance record .....	10-5

# LOCATION OF IMPORTANT LABELS

---

EAU10383

Read and understand all of the labels on your vehicle. They contain important information for safe and proper operation of your vehicle. Never remove any labels from your vehicle. If a label becomes difficult to read or comes off, a replacement label is available from your Yamaha dealer.

1

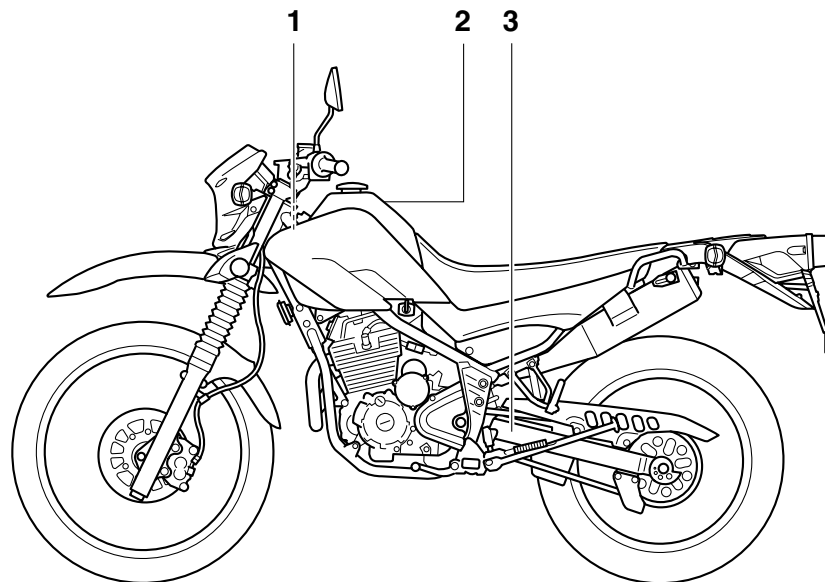



# LOCATION OF IMPORTANT LABELS

## 1 California only

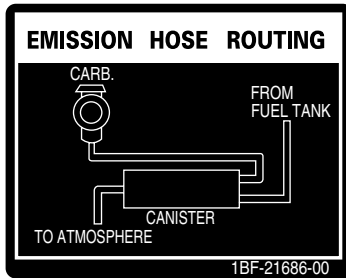

## 3

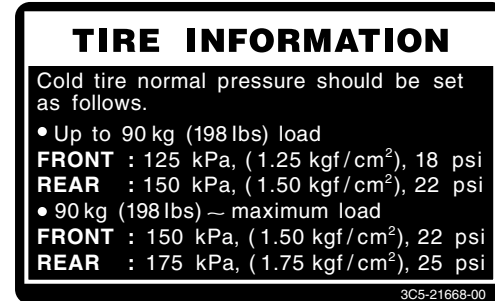

1

## 2



# LOCATION OF IMPORTANT LABELS

---

1

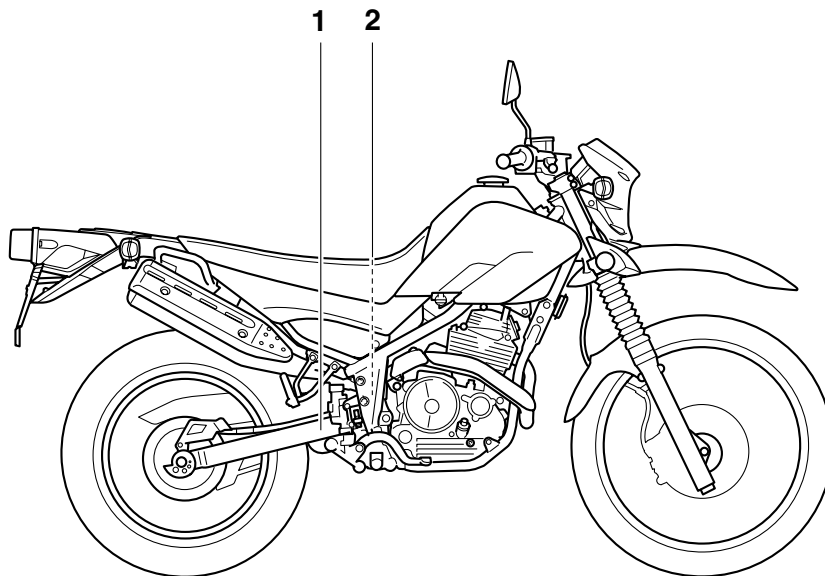

# LOCATION OF IMPORTANT LABELS

1



2

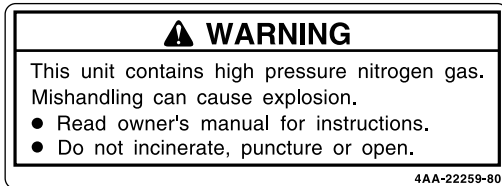

1

# SAFETY INFORMATION

EAU10313

## Be a Responsible Owner

As the vehicle's owner, you are responsible for the safe and proper operation of your motorcycle.

Motorcycles are single-track vehicles.

Their safe use and operation are dependent upon the use of proper riding techniques as well as the expertise of the operator. Every operator should know the following requirements before riding this motorcycle.

He or she should:

- Obtain thorough instructions from a competent source on all aspects of motorcycle operation.
- Observe the warnings and maintenance requirements in this Owner's Manual.
- Obtain qualified training in safe and proper riding techniques.
- Obtain professional technical service as indicated in this Owner's Manual and/or when made necessary by mechanical conditions.

## Safe Riding

Perform the pre-operation checks each

time you use the vehicle to make sure it is in safe operating condition. Failure to inspect or maintain the vehicle properly increases the possibility of an accident or equipment damage. See page 5-1 for a list of pre-operation checks.

- This motorcycle is designed to carry the operator and a passenger.
- The failure of motorists to detect and recognize motorcycles in traffic is the predominating cause of automobile/motorcycle accidents. Many accidents have been caused by an automobile driver who did not see the motorcycle. Making yourself conspicuous appears to be very effective in reducing the chance of this type of accident.

### Therefore:

- Wear a brightly colored jacket.
- Use extra caution when you are approaching and passing through intersections, since intersections are the most likely places for motorcycle accidents to occur.
- Ride where other motorists can see you. Avoid riding in another

motorist's blind spot.

- Many accidents involve inexperienced operators. In fact, many operators who have been involved in accidents do not even have a current motorcycle license.
  - Make sure that you are qualified and that you only lend your motorcycle to other qualified operators.
  - Know your skills and limits. Staying within your limits may help you to avoid an accident.
  - We recommend that you practice riding your motorcycle where there is no traffic until you have become thoroughly familiar with the motorcycle and all of its controls.
- Many accidents have been caused by error of the motorcycle operator. A typical error made by the operator is veering wide on a turn due to excessive speed or undercornering (insufficient lean angle for the speed).
  - Always obey the speed limit and never travel faster than warrant-

ed by road and traffic conditions.

- Always signal before turning or changing lanes. Make sure that other motorists can see you.
- The posture of the operator and passenger is important for proper control.
- The operator should keep both hands on the handlebar and both feet on the operator footrests during operation to maintain control of the motorcycle.
- The passenger should always hold onto the operator, the seat strap or grab bar, if equipped, with both hands and keep both feet on the passenger footrests. Never carry a passenger unless he or she can firmly place both feet on the passenger footrests.
- Never ride under the influence of alcohol or other drugs.

### **Protective apparel**

The majority of fatalities from motorcycle accidents are the result of head injuries. The use of a safety helmet is the single most critical factor in the preven-

tion or reduction of head injuries.

- Always wear an approved helmet.
- Wear a face shield or goggles. Wind in your unprotected eyes could contribute to an impairment of vision that could delay seeing a hazard.
- The use of a jacket, heavy boots, trousers, gloves, etc., is effective in preventing or reducing abrasions or lacerations.
- Never wear loose-fitting clothes, otherwise they could catch on the control levers, footrests, or wheels and cause injury or an accident.
- Always wear protective clothing that covers your legs, ankles, and feet. The engine or exhaust system become very hot during or after operation and can cause burns.
- A passenger should also observe the above precautions.

### **Avoid Carbon Monoxide Poisoning**

All engine exhaust contains carbon monoxide, a deadly gas. Breathing carbon monoxide can cause headaches, dizziness, drowsiness, nausea, confu-

sion, and eventually death.

Carbon Monoxide is a colorless, odorless, tasteless gas which may be present even if you do not see or smell any engine exhaust. Deadly levels of carbon monoxide can collect rapidly and you can quickly be overcome and unable to save yourself. Also, deadly levels of carbon monoxide can linger for hours or days in enclosed or poorly ventilated areas. If you experience any symptoms of carbon monoxide poisoning, leave the area immediately, get fresh air, and **SEEK MEDICAL TREATMENT.**

- Do not run engine indoors. Even if you try to ventilate engine exhaust with fans or open windows and doors, carbon monoxide can rapidly reach dangerous levels.
- Do not run engine in poorly ventilated or partially enclosed areas such as barns, garages, or carports.
- Do not run engine outdoors where engine exhaust can be drawn into a building through openings such as windows and doors.

# SAFETY INFORMATION

2

## Loading

Adding accessories or cargo to your motorcycle can adversely affect stability and handling if the weight distribution of the motorcycle is changed. To avoid the possibility of an accident, use extreme caution when adding cargo or accessories to your motorcycle. Use extra care when riding a motorcycle that has added cargo or accessories. Here, along with the information about accessories below, are some general guidelines to follow if loading cargo to your motorcycle:

The total weight of the operator, passenger, accessories and cargo must not exceed the maximum load limit.

**Operation of an overloaded vehicle could cause an accident.**

**Maximum load:**  
160 kg (353 lb)

When loading within this weight limit, keep the following in mind:

- Cargo and accessory weight should be kept as low and close to the motorcycle as possible. Securely pack your heaviest items as

close to the center of the vehicle as possible and make sure to distribute the weight as evenly as possible on both sides of the motorcycle to minimize imbalance or instability.

- Shifting weights can create a sudden imbalance. Make sure that accessories and cargo are securely attached to the motorcycle before riding. Check accessory mounts and cargo restraints frequently.
  - Properly adjust the suspension for your load, and check the condition and pressure of your tires.
  - Never attach any large or heavy items to the handlebar, front fork, or front fender. These items, including such cargo as sleeping bags, duffel bags, or tents, can create unstable handling or a slow steering response.
- **This vehicle is not designed to pull a trailer or to be attached to a sidecar.**

## Genuine Yamaha Accessories

Choosing accessories for your vehicle is an important decision. Genuine Yamaha accessories, which are available only from a Yamaha dealer, have been designed, tested, and approved by Yamaha for use on your vehicle.

Many companies with no connection to Yamaha manufacture parts and accessories or offer other modifications for Yamaha vehicles. Yamaha is not in a position to test the products that these aftermarket companies produce. Therefore, Yamaha can neither endorse nor recommend the use of accessories not sold by Yamaha or modifications not specifically recommended by Yamaha, even if sold and installed by a Yamaha dealer.

## Aftermarket Parts, Accessories, and Modifications

While you may find aftermarket products similar in design and quality to genuine Yamaha accessories, recognize that some aftermarket accessories or modifications are not suitable because of potential safety hazards to you

or others. Installing aftermarket products or having other modifications performed to your vehicle that change any of the vehicle's design or operation characteristics can put you and others at greater risk of serious injury or death. You are responsible for injuries related to changes in the vehicle.

Keep the following guidelines in mind, as well as those provided under "Loading" when mounting accessories.

- Never install accessories or carry cargo that would impair the performance of your motorcycle. Carefully inspect the accessory before using it to make sure that it does not in any way reduce ground clearance or cornering clearance, limit suspension travel, steering travel or control operation, or obscure lights or reflectors.
- Accessories fitted to the handlebar or the front fork area can create instability due to improper weight distribution or aerodynamic changes. If accessories are added to the handlebar or front fork area, they must be as

lightweight as possible and should be kept to a minimum.

- Bulky or large accessories may seriously affect the stability of the motorcycle due to aerodynamic effects. Wind may attempt to lift the motorcycle, or the motorcycle may become unstable in cross winds. These accessories may also cause instability when passing or being passed by large vehicles.
- Certain accessories can displace the operator from his or her normal riding position. This improper position limits the freedom of movement of the operator and may limit control ability, therefore, such accessories are not recommended.
- Use caution when adding electrical accessories. If electrical accessories exceed the capacity of the motorcycle's electrical system, an electric failure could result, which could cause a dangerous loss of lights or engine power.

### **Aftermarket Tires and Rims**

The tires and rims that came with your motorcycle were designed to match the performance capabilities and to provide the best combination of handling, braking, and comfort. Other tires, rims, sizes, and combinations may not be appropriate. Refer to page 7-19 for tire specifications and more information on replacing your tires.

# DESCRIPTION

---

EAU10410

## Left view

3

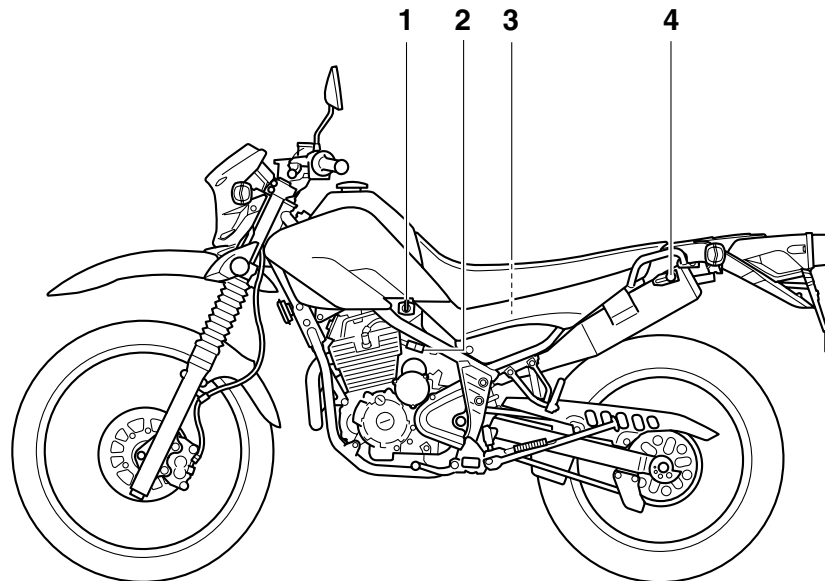

1. Fuel cock (page 4-8)
2. Starter (choke) knob (page 4-9)
3. Air filter element (page 7-16)
4. Helmet holder (page 4-10)



## Right view

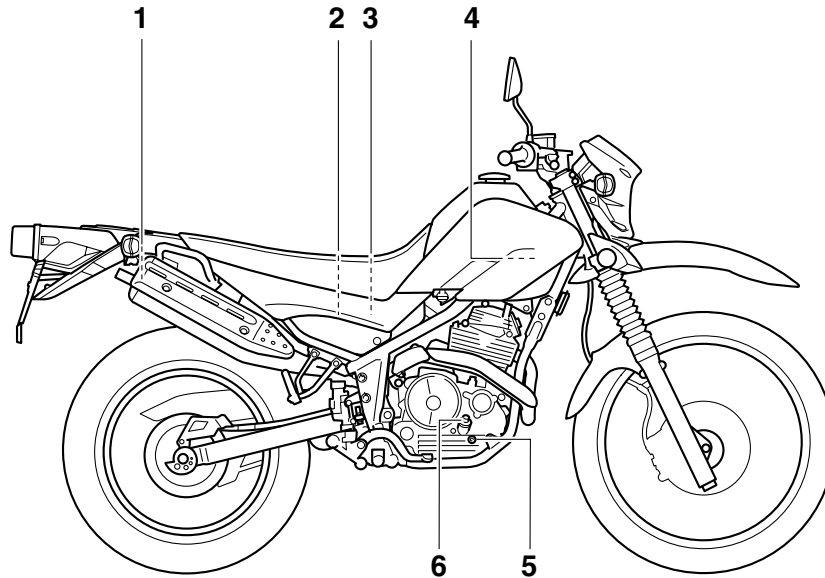

1. Spark arrester (page 7-17)
2. Battery (page 7-31)
3. Fuse (page 7-32)
4. Owner's tool kit (page 7-2)
5. Engine oil level check window (page 7-13)
6. Engine oil filler bolt (page 7-13)

# DESCRIPTION

EAU10430

## Controls and instruments

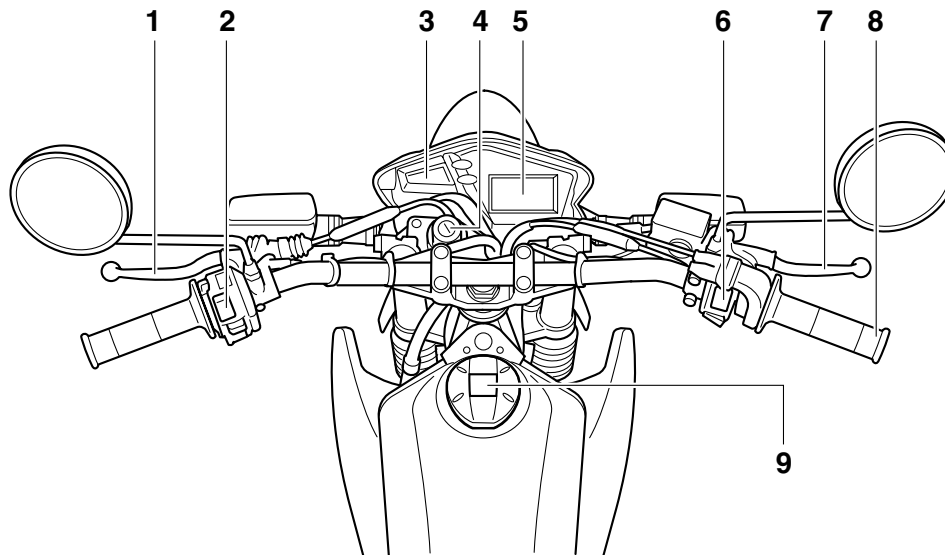

1. Clutch lever (page 4-5)
2. Left handlebar switches (page 4-4)
3. Indicator lights (page 4-2)
4. Main switch/steering lock (page 4-1)
5. Multi-function display (page 4-3)
6. Right handlebar switches (page 4-4)
7. Brake lever (page 4-6)

8. Throttle grip (page 7-18)
9. Fuel tank cap (page 4-6)

# INSTRUMENT AND CONTROL FUNCTIONS

## Main switch/steering lock

EAU10460

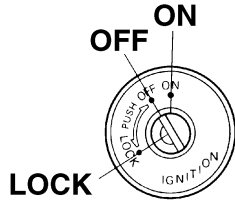

The main switch/steering lock controls the ignition and lighting systems, and is used to lock the steering. The various positions are described below.

### ON

EAU10580

All electrical circuits are supplied with power, and the meter lighting, taillight and position lights come on, and the engine can be started. The key cannot be removed.

### TIP

The headlight comes on automatically when the engine is started and stays on until the key is turned to "OFF", even if

the engine stalls.

EAU10661

### OFF

All electrical systems are off. The key can be removed.

EWA10061



**Never turn the key to "OFF" or "LOCK" while the vehicle is moving. Otherwise the electrical systems will be switched off, which may result in loss of control or an accident.**

EAU10691

### LOCK

The steering is locked, and all electrical systems are off. The key can be removed.

To lock the steering

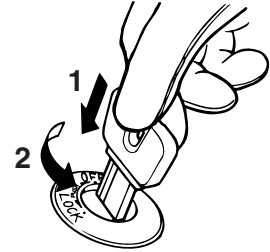

1. Push.
2. Turn.

1. Turn the handlebars all the way to the left or right.
2. Push the key in from the "OFF" position, and then turn it to "LOCK" while still pushing it.
3. Remove the key.

# INSTRUMENT AND CONTROL FUNCTIONS

To unlock the steering

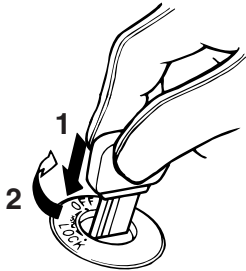

4

1. Push.
2. Turn.

Push the key into the main switch, and then turn it to “OFF” while still pushing it.

## Indicator lights

EAU10981

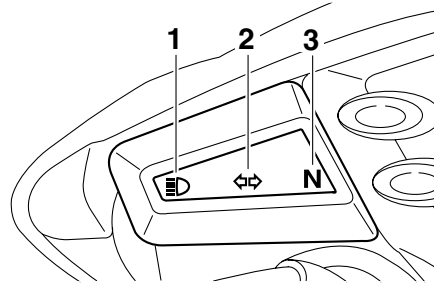

1. High beam indicator light “ $\equiv \circ$ ”
2. Turn signal indicator light “ $\leftarrow \rightarrow$ ”
3. Neutral indicator light “**N**”

EAU11020

## Turn signal indicator light “ $\leftarrow \rightarrow$ ”

This indicator light flashes when the turn signal switch is pushed to the left or right.

EAU11060

## Neutral indicator light “**N**”

This indicator light comes on when the transmission is in the neutral position.

EAU11080

## High beam indicator light “ $\equiv \circ$ ”

This indicator light comes on when the high beam of the headlight is switched on.

# INSTRUMENT AND CONTROL FUNCTIONS

## Multi-function display

EAU44862

EWA12312

### WARNING

Be sure to stop the vehicle before making any setting changes to the multi-function display. Changing settings while riding can distract the operator and increase the risk of an accident.

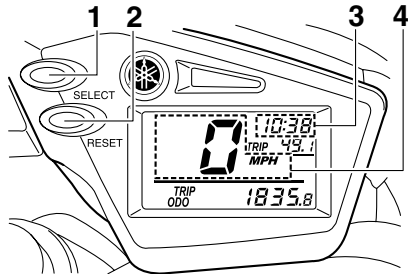

1. “SELECT” button
2. “RESET” button
3. Clock
4. Speedometer

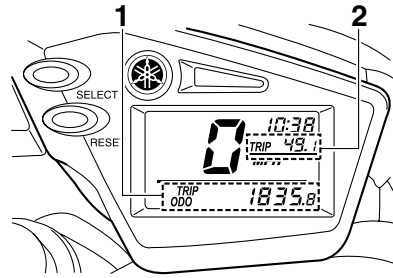

1. Odometer/tripmeter (bottom)
2. Tripmeter (top)

The multi-function display is equipped with the following:

- a speedometer (which shows the riding speed)
- an odometer (which shows the total distance traveled)
- two tripmeters (which show the distance traveled since they were last set to zero)
- a clock

### TIP

- Be sure to turn the key to “ON” before using the “SELECT” and “RESET” buttons.
- When the key is turned to “ON”, all of the display segments of the

multi-function display will appear one after the other and then disappear, in order to test the electrical circuit.

- To switch the speedometer and odometer/tripmeter displays between miles and kilometers, press the “SELECT” button for at least two seconds.

### Odometer, clock and tripmeter modes

Pushing the “SELECT” button switches the display between the odometer mode “ODO” and the tripmeter modes “TRIP” in the following order:  
ODO → TRIP (top) → TRIP (bottom) → ODO

To reset a tripmeter, select it by pushing the “SELECT” button until “TRIP” begins flashing (“TRIP” will only flash for five seconds). While “TRIP” is flashing, push the “RESET” button for at least one second.

# INSTRUMENT AND CONTROL FUNCTIONS

## Clock mode

### To set the clock:

1. Push the “SELECT” button and “RESET” button together for at least two seconds.
2. When the hour digits start flashing, push the “RESET” button to set the hours.
3. Push the “SELECT” button, and the minute digits will start flashing.
4. Push the “RESET” button to set the minutes.
5. Push the “SELECT” button and then release it to start the clock.

## Handlebar switches

EAU12348

### Left

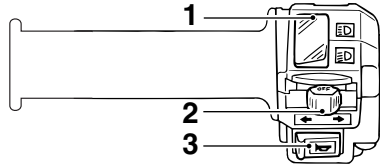

1. Dimmer switch “ $\equiv\text{O}/\text{O}\equiv$ ”
2. Turn signal switch “ $\leftarrow/\rightarrow$ ”
3. Horn switch “ $\text{H}$ ”

### Right

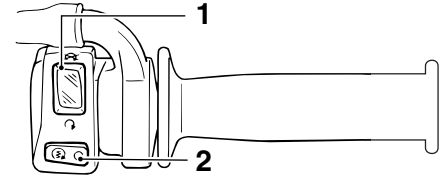

1. Engine stop switch “ $\text{O}/\text{X}$ ”
2. Start switch “ $\text{O}$ ”

EAU12400

### Dimmer switch “ $\equiv\text{O}/\text{O}\equiv$ ”

Set this switch to “ $\equiv\text{O}$ ” for the high beam and to “ $\text{O}\equiv$ ” for the low beam.

EAU12460

### Turn signal switch “ $\leftarrow/\rightarrow$ ”

To signal a right-hand turn, push this switch to “ $\rightarrow$ ”. To signal a left-hand turn, push this switch to “ $\leftarrow$ ”. When released, the switch returns to the center position. To cancel the turn signal lights, push the switch in after it has returned to the center position.

# INSTRUMENT AND CONTROL FUNCTIONS



## Horn switch “”

EAU12500

Press this switch to sound the horn.

## Engine stop switch “”

EAU12660

Set this switch to “” before starting the engine. Set this switch to “” to stop the engine in case of an emergency, such as when the vehicle overturns or when the throttle cable is stuck.

## Start switch “”

EAU12711

Push this switch to crank the engine with the starter. See page 6-1 for starting instructions prior to starting the engine.

## Clutch lever

EAU12820

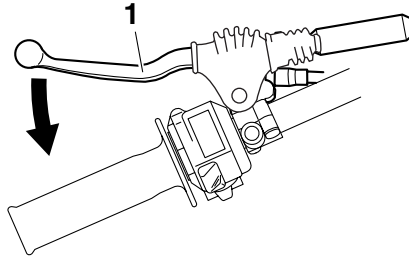

1. Clutch lever

The clutch lever is located at the left handlebar grip. To disengage the clutch, pull the lever toward the handlebar grip. To engage the clutch, release the lever. The lever should be pulled rapidly and released slowly for smooth clutch operation.

The clutch lever is equipped with a clutch switch, which is part of the ignition circuit cut-off system. (See page 4-13.)

## Shift pedal

EAU12870

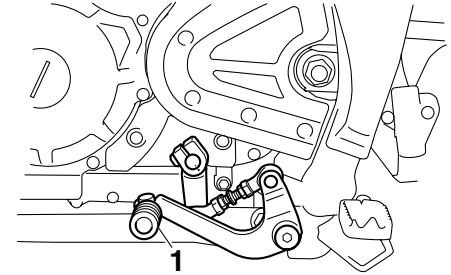

1. Shift pedal

The shift pedal is located on the left side of the engine and is used in combination with the clutch lever when shifting the gears of the 5-speed constant-mesh transmission equipped on this motorcycle.

# INSTRUMENT AND CONTROL FUNCTIONS

EAU12890

## Brake lever

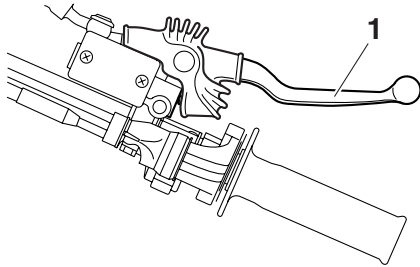

1. Brake lever

The brake lever is located at the right handlebar grip. To apply the front brake, pull the lever toward the handlebar grip.

EAU12941

## Brake pedal

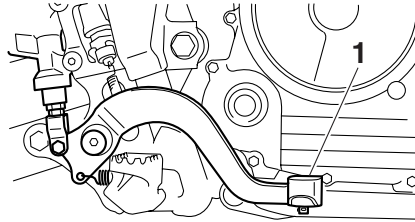

1. Brake pedal

The brake pedal is on the right side of the motorcycle. To apply the rear brake, press down on the brake pedal.

EAUM1793

## Fuel tank cap

### To remove the fuel tank cap

1. Open the fuel tank cap lock cover.
2. Insert the key into the lock and turn it 1/4 turn clockwise. The lock will be released and the fuel tank cap can be removed.

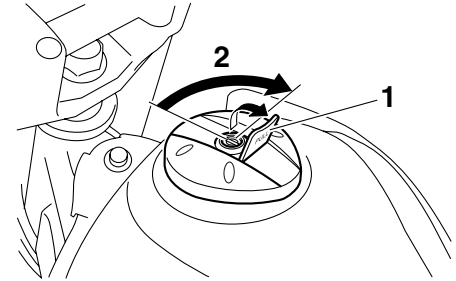

1. Fuel tank cap lock cover
2. Unlock.

### To install the fuel tank cap

1. Push and install the fuel tank cap into position with the key inserted in the lock.
2. Turn the key counterclockwise to the original position, and then remove it.



# INSTRUMENT AND CONTROL FUNCTIONS

EAU13212

## Fuel

Make sure there is sufficient gasoline in the tank.

EWA10881

### **WARNING**

**Gasoline and gasoline vapors are extremely flammable. To avoid fires and explosions and to reduce the risk of injury when refueling, follow these instructions.**

1. Before refueling, turn off the engine and be sure that no one is sitting on the vehicle. Never refuel while smoking, or while in the vicinity of sparks, open flames, or other sources of ignition such as the pilot lights of water heaters and clothes dryers.
2. Do not overfill the fuel tank. Stop filling when the fuel reaches the bottom of the filler tube. Because fuel expands when it heats up, heat from the engine or the sun can cause fuel to spill out of the fuel tank.

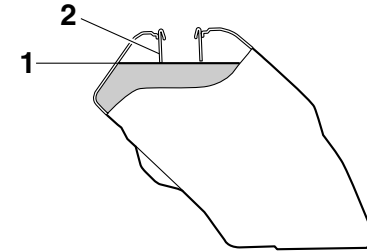

1. Fuel level
2. Fuel tank filler tube
3. Wipe up any spilled fuel immediately. **NOTICE: Immediately wipe off spilled fuel with a clean, dry, soft cloth, since fuel may deteriorate painted surfaces or plastic parts.**<sup>[ECA10071]</sup>
4. Be sure to securely close the fuel tank cap.

EWA15151

### **WARNING**

**Gasoline is poisonous and can cause injury or death. Handle gasoline with care. Never siphon gasoline by mouth. If you should swallow some gasoline or inhale a lot of gasoline vapor, or get some gasoline in**

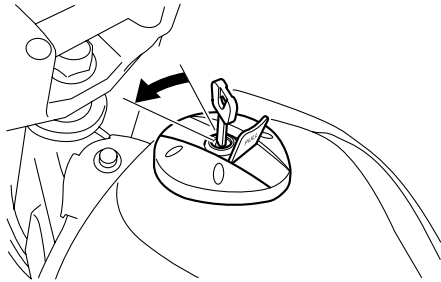

## TIP

The fuel tank cap cannot be installed unless the key is in the lock. In addition, the key cannot be removed if the cap is not properly installed and locked.

3. Close the lock cover.

EWA11141

### **WARNING**

**Make sure that the fuel tank cap is properly installed before riding. Leaking fuel is a fire hazard.**

# INSTRUMENT AND CONTROL FUNCTIONS

**your eyes, see your doctor immediately. If gasoline spills on your skin, wash with soap and water. If gasoline spills on your clothing, change your clothes.**

EAU13301

## Recommended fuel:

UNLEADED GASOLINE ONLY

## Fuel tank capacity:

9.1 L (2.40 US gal, 2.00 Imp.gal)  
(CAL)

9.8 L (2.59 US gal, 2.16 Imp.gal)  
(U49)

## Fuel reserve amount:

1.9 L (0.50 US gal, 0.42 Imp.gal)

ECA11400

## NOTICE

**Use only unleaded gasoline. The use of leaded gasoline will cause severe damage to internal engine parts, such as the valves and piston rings, as well as to the exhaust system.**

Your Yamaha engine has been designed to use regular unleaded gasoline with a pump octane number [(R+M)/2] of 86 or higher, or a research

octane number of 91 or higher. If knocking (or pinging) occurs, use a gasoline of a different brand or premium unleaded fuel. Use of unleaded fuel will extend spark plug life and reduce maintenance costs.

## Gasohol

There are two types of gasohol: gasohol containing ethanol and that containing methanol. Gasohol containing ethanol can be used if the ethanol content does not exceed 10% (E10). Gasohol containing methanol is not recommended by Yamaha because it can cause damage to the fuel system or vehicle performance problems.

EAU13561

## Fuel cock

The fuel cock supplies fuel from the tank to the carburetor while filtering it also.

The fuel cock has three positions:

## OFF

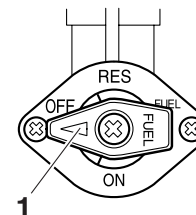

1. Pointed end positioned under "OFF"

With the lever in this position, fuel will not flow. Always return the lever to this position when the engine is not running.

# INSTRUMENT AND CONTROL FUNCTIONS

## ON

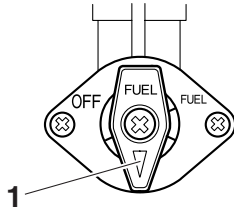

1. Pointed end positioned over "ON"

With the lever in this position, fuel flows to the carburetor. Normal riding is done with the lever in this position.

## RES

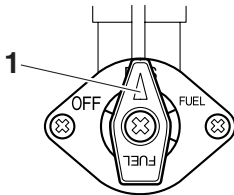



1. Pointed end positioned over "RES"

This indicates reserve. If you run out of fuel while riding, move the lever to this position. Fill the tank at the first opportunity. Be sure to set the lever back to "ON" after refueling!

## Starter (choke) knob “”

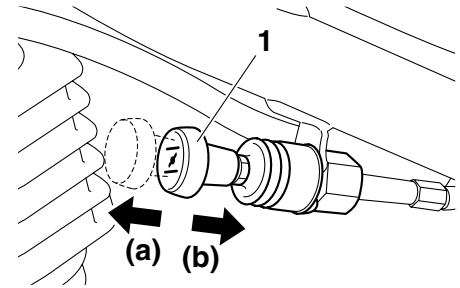
EAU13600



1. Starter (choke) knob “”

Starting a cold engine requires a richer air-fuel mixture, which is supplied by the starter (choke).

Move the knob in direction (a) to turn on the starter (choke).

Move the knob in direction (b) to turn off the starter (choke).

# INSTRUMENT AND CONTROL FUNCTIONS

## Seat

EAU13970

### To remove the seat

Remove the bolts, and then pull the seat off.

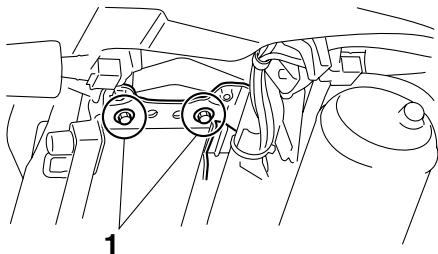

1. Bolt

### To install the seat

1. Insert the projection on the front of the seat into the seat holder as shown.

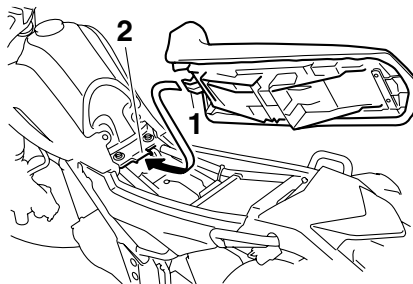

1. Projection
2. Seat holder

2. Place the seat in the original position, and then tighten the bolts.

### TIP

Make sure that the seat is properly secured before riding.

## Helmet holder

EAU14282

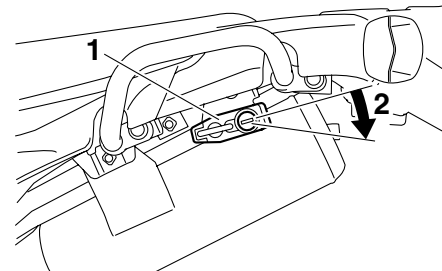

1. Helmet holder
2. Unlock.

To open the helmet holder, insert the key into the lock, and then turn the key as shown.

To lock the helmet holder, place it in the original position, and then remove the key. **WARNING! Never ride with a helmet attached to the helmet holder, since the helmet may hit objects, causing loss of control and possibly an accident.**<sub>[EWA10161]</sub>

## Adjusting the shock absorber assembly

EAU44772

This shock absorber assembly is equipped with a spring preload adjusting ring.

It is recommended to have a Yamaha dealer adjust the spring preload. However, if you choose to make this adjustment yourself, obtain a special wrench at a Yamaha dealer.

ECA10101

### NOTICE

To avoid damaging the mechanism, do not attempt to turn beyond the maximum or minimum settings.

1. Loosen the locknut.
2. To increase the spring preload and thereby harden the suspension, turn the adjusting ring in direction (a). To decrease the spring preload and thereby soften the suspension, turn the adjusting ring in direction (b).

The spring preload setting is determined by measuring distance A, shown in the illustration. The shorter the distance A is, the higher the

spring preload; the longer distance A is, the lower the spring preload.

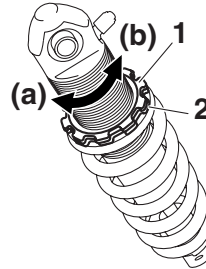

1. Locknut
2. Spring preload adjusting ring

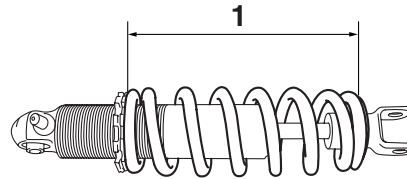

1. Distance A

### Spring preload:

Minimum (soft):

Distance A = 207 mm (8.15 in)

Standard:

Distance A = 197 mm (7.76 in)

Maximum (hard):

Distance A = 187 mm (7.36 in)

3. Tighten the locknut to the specified torque. **NOTICE: Always tighten the locknut against the adjusting ring, and then tighten the locknut to the specified torque.**<sup>[ECA10131]</sup>

### Tightening torque:

Locknut:

30 Nm (3.0 m·kgf, 21.7 ft·lbf)

EWA10221

### WARNING

This shock absorber assembly contains highly pressurized nitrogen gas. Read and understand the following information before handling the shock absorber assembly.

- Do not tamper with or attempt to open the cylinder assembly.
- Do not subject the shock absorber assembly to an open

# INSTRUMENT AND CONTROL FUNCTIONS

---

flame or other high heat source. This may cause the unit to explode due to excessive gas pressure.

- Do not deform or damage the cylinder in any way. Cylinder damage will result in poor damping performance.
  - Do not dispose of a damaged or worn-out shock absorber assembly yourself. Take the shock absorber assembly to a Yamaha dealer for any service.
- 

EAU15303

## Sidestand

The sidestand is located on the left side of the frame. Raise the sidestand or lower it with your foot while holding the vehicle upright.

### TIP

The built-in sidestand switch is part of the ignition circuit cut-off system, which cuts the ignition in certain situations. (See page 4-13 for an explanation of the ignition circuit cut-off system.)

EWA10240

### WARNING

The vehicle must not be ridden with the sidestand down, or if the sidestand cannot be properly moved up (or does not stay up), otherwise the sidestand could contact the ground and distract the operator, resulting in a possible loss of control. Yamaha's ignition circuit cut-off system has been designed to assist the operator in fulfilling the responsibility of raising the sidestand before starting off. Therefore, check this system regularly as described below and have a Yamaha dealer re-

pair it if it does not function properly.

---

EAU15314

## Ignition circuit cut-off system

The ignition circuit cut-off system (comprising the sidestand switch, clutch switch and neutral switch) has the following functions.

- It prevents starting when the transmission is in gear and the sidestand is up, but the clutch lever is not pulled.
- It prevents starting when the transmission is in gear and the clutch lever is pulled, but the sidestand is still down.
- It cuts the running engine when the transmission is in gear and the sidestand is moved down.

Periodically check the operation of the ignition circuit cut-off system according to the following procedure.

### **TIP** \_\_\_\_\_

This check is most reliable if performed with a warmed-up engine.

---

# INSTRUMENT AND CONTROL FUNCTIONS

With the engine turned off:

1. Move the sidestand down.
2. Make sure that the engine stop switch is set to “O”.
3. Turn the key on.
4. Shift the transmission into the neutral position.
5. Push the start switch.

**Does the engine start?**

YES

NO

With the engine still running:

6. Move the sidestand up.
7. Keep the clutch lever pulled.
8. Shift the transmission into gear.
9. Move the sidestand down.

**Does the engine stall?**

YES

NO

After the engine has stalled:

10. Move the sidestand up.
11. Keep the clutch lever pulled.
12. Push the start switch.

**Does the engine start?**

YES

NO

The system is OK. **The motorcycle can be ridden.**



**If a malfunction is noted, have a Yamaha dealer check the system before riding.**

The neutral switch may not be working correctly.  
**The motorcycle should not be ridden** until checked by a Yamaha dealer.

The sidestand switch may not be working correctly.  
**The motorcycle should not be ridden** until checked by a Yamaha dealer.

The clutch switch may not be working correctly.  
**The motorcycle should not be ridden** until checked by a Yamaha dealer.



# FOR YOUR SAFETY – PRE-OPERATION CHECKS

EAU15596

Inspect your vehicle each time you use it to make sure the vehicle is in safe operating condition. Always follow the inspection and maintenance procedures and schedules described in the Owner's Manual.

EWA11151

## **WARNING**

**Failure to inspect or maintain the vehicle properly increases the possibility of an accident or equipment damage. Do not operate the vehicle if you find any problem. If a problem cannot be corrected by the procedures provided in this manual, have the vehicle inspected by a Yamaha dealer.**

Before using this vehicle, check the following points:

ITEM	CHECKS	PAGE
Fuel	<ul style="list-style-type: none"><li>• Check fuel level in fuel tank.</li><li>• Refuel if necessary.</li><li>• Check fuel line for leakage.</li></ul>	4-7
Engine oil	<ul style="list-style-type: none"><li>• Check oil level in engine.</li><li>• If necessary, add recommended oil to specified level.</li><li>• Check vehicle for oil leakage.</li></ul>	7-13
Front brake	<ul style="list-style-type: none"><li>• Check operation.</li><li>• If soft or spongy, have Yamaha dealer bleed hydraulic system.</li><li>• Check lever free play.</li><li>• Adjust if necessary.</li><li>• Check brake pads for wear.</li><li>• Replace if necessary.</li><li>• Check fluid level in reservoir.</li><li>• If necessary, add recommended brake fluid to specified level.</li><li>• Check hydraulic system for leakage.</li></ul>	7-22, 7-24
Rear brake	<ul style="list-style-type: none"><li>• Check operation.</li><li>• If soft or spongy, have Yamaha dealer bleed hydraulic system.</li><li>• Check brake pads for wear.</li><li>• Replace if necessary.</li><li>• Check fluid level in reservoir.</li><li>• If necessary, add recommended brake fluid to specified level.</li><li>• Check hydraulic system for leakage.</li></ul>	7-23

# FOR YOUR SAFETY – PRE-OPERATION CHECKS

ITEM	CHECKS	PAGE
<b>Clutch</b>	<ul style="list-style-type: none"> <li>• Check operation.</li> <li>• Lubricate cable if necessary.</li> <li>• Check lever free play.</li> <li>• Adjust if necessary.</li> </ul>	7-21
<b>Throttle grip</b>	<ul style="list-style-type: none"> <li>• Make sure that operation is smooth.</li> <li>• Check cable free play.</li> <li>• If necessary, have Yamaha dealer adjust cable free play and lubricate cable and grip housing.</li> </ul>	7-18, 7-27
<b>Control cables</b>	<ul style="list-style-type: none"> <li>• Make sure that operation is smooth.</li> <li>• Lubricate if necessary.</li> </ul>	7-27
<b>Drive chain</b>	<ul style="list-style-type: none"> <li>• Check chain slack.</li> <li>• Adjust if necessary.</li> <li>• Check chain condition.</li> <li>• Lubricate if necessary.</li> </ul>	7-25, 7-26
<b>Wheels and tires</b>	<ul style="list-style-type: none"> <li>• Check for damage.</li> <li>• Check tire condition and tread depth.</li> <li>• Check air pressure.</li> <li>• Correct if necessary.</li> </ul>	7-19, 7-21
<b>Brake and shift pedals</b>	<ul style="list-style-type: none"> <li>• Make sure that operation is smooth.</li> <li>• Lubricate pedal pivoting points if necessary.</li> </ul>	7-27
<b>Brake and clutch levers</b>	<ul style="list-style-type: none"> <li>• Make sure that operation is smooth.</li> <li>• Lubricate lever pivoting points if necessary.</li> </ul>	7-28
<b>Sidestand</b>	<ul style="list-style-type: none"> <li>• Make sure that operation is smooth.</li> <li>• Lubricate pivot if necessary.</li> </ul>	7-29
<b>Chassis fasteners</b>	<ul style="list-style-type: none"> <li>• Make sure that all nuts, bolts and screws are properly tightened.</li> <li>• Tighten if necessary.</li> </ul>	—
<b>Instruments, lights, signals and switches</b>	<ul style="list-style-type: none"> <li>• Check operation.</li> <li>• Correct if necessary.</li> </ul>	—
<b>Sidestand switch</b>	<ul style="list-style-type: none"> <li>• Check operation of ignition circuit cut-off system.</li> <li>• If system is not working correctly, have Yamaha dealer check vehicle.</li> </ul>	4-12

# OPERATION AND IMPORTANT RIDING POINTS

EAU15951

Read the Owner's Manual carefully to become familiar with all controls. If there is a control or function you do not understand, ask your Yamaha dealer.

EWA10271



**Failure to familiarize yourself with the controls can lead to loss of control, which could cause an accident or injury.**

EAU15997

## Starting and warming up a cold engine

In order for the ignition circuit cut-off system to enable starting, one of the following conditions must be met:

- The transmission is in the neutral position.
- The transmission is in gear with the clutch lever pulled and the sidestand up.  
See page 4-13 for more information.

1. Turn the fuel cock lever to "ON".
2. Turn the key to "ON" and make sure that the engine stop switch is set to "○".
3. Shift the transmission into the neutral position. (See page 6-2.) The neutral indicator light should come on. If not, ask a Yamaha dealer to check the electrical circuit.
4. Turn the starter (choke) on and completely close the throttle. (See page 4-9.)
5. Start the engine by pushing the start switch.

If the engine fails to start, release

the start switch, wait a few seconds, and then try again. Each starting attempt should be as short as possible to preserve the battery. Do not crank the engine more than 10 seconds on any one attempt.

6. After starting the engine, move the starter (choke) back halfway.

**NOTICE: For maximum engine life, never accelerate hard when the engine is cold!**<sup>[ECA11041]</sup>

7. When the engine is warm, turn the starter (choke) off.

## TIP

The engine is warm when it responds normally to the throttle with the starter (choke) turned off. To avoid the possibility of excessive exhaust emissions, never leave the starter (choke) on longer than necessary. The time necessary for starter (choke) use depends upon the ambient temperature. Temperatures above 10 °C (50 °F) require about 7 seconds of starter (choke) use and temperatures below 10 °C (50 °F) require about 35 seconds with the starter (choke) turned on, then about

# OPERATION AND IMPORTANT RIDING POINTS

2.5 minutes with the starter (choke) in the halfway position.

## Starting a warm engine

Follow the same procedure as for starting a cold engine with the exception that the starter (choke) is not required when the engine is warm.

EAU16640

## Shifting

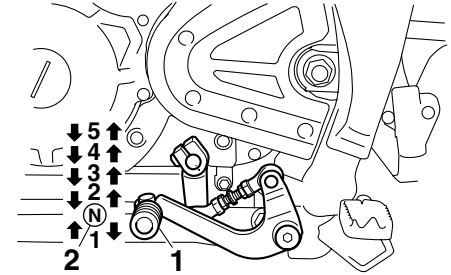

EAU16671

1. Shift pedal
2. Neutral position

Shifting gears lets you control the amount of engine power available for starting off, accelerating, climbing hills, etc.

The gear positions are shown in the illustration.

### TIP

To shift the transmission into the neutral position, press the shift pedal down repeatedly until it reaches the end of its travel, and then slightly raise it.

ECA10260

### NOTICE

- Even with the transmission in

# OPERATION AND IMPORTANT RIDING POINTS

the neutral position, do not coast for long periods of time with the engine off, and do not tow the motorcycle for long distances. The transmission is properly lubricated only when the engine is running. Inadequate lubrication may damage the transmission.

- Always use the clutch while changing gears to avoid damaging the engine, transmission, and drive train, which are not designed to withstand the shock of forced shifting.

EAU16681

## To start out and accelerate

1. Pull the clutch lever to disengage the clutch.
2. Shift the transmission into first gear. The neutral indicator light should go out.
3. Open the throttle gradually, and at the same time, release the clutch lever slowly.
4. At the recommended shift points shown in the following table, close

the throttle, and at the same time, quickly pull the clutch lever in.

5. Shift the transmission into second gear. (Make sure not to shift the transmission into the neutral position.)
6. Open the throttle part way and gradually release the clutch lever.
7. Follow the same procedure when shifting to the next higher gear.

## TIP

When shifting gears in normal operating conditions, use the recommended shift points.

EAU16700

## To decelerate

1. Apply both the front and the rear brakes to slow the motorcycle.
2. Shift the transmission into first gear when the motorcycle reaches 20 km/h (12 mi/h). If the engine is about to stall or runs very roughly, pull the clutch lever in and use the brakes to stop the motorcycle.
3. Shift the transmission into the neutral position when the motorcycle is almost completely stopped. The

neutral indicator light should come on.

EAU16720

## Recommended shift points

The recommended shift points during acceleration and deceleration are shown in the table below.

### Shift up points:

- 1st → 2nd: 16 km/h (10 mi/h)
- 2nd → 3rd: 24 km/h (15 mi/h)
- 3rd → 4th: 32 km/h (20 mi/h)
- 4th → 5th: 40 km/h (25 mi/h)

### Shift down points:

- 5th → 4th: 20 km/h (12 mi/h)
- 4th → 3rd: 20 km/h (12 mi/h)
- 3rd → 2nd: 20 km/h (12 mi/h)
- 2nd → 1st: 20 km/h (12 mi/h)

# OPERATION AND IMPORTANT RIDING POINTS

---

6

## Engine break-in

EAU16841

There is never a more important period in the life of your engine than the period between 0 and 1600 km (1000 mi). For this reason, you should read the following material carefully.

Since the engine is brand new, do not put an excessive load on it for the first 1600 km (1000 mi). The various parts in the engine wear and polish themselves to the correct operating clearances. During this period, prolonged full-throttle operation or any condition that might result in engine overheating must be avoided.

EAU17023

## 0–1000 km (0–600 mi)

Avoid prolonged operation above 1/3 throttle. **NOTICE: After 1000 km (600 mi) of operation, the engine oil must be changed, and the oil filter cartridge or element replaced.**<sup>[ECA11282]</sup>

## 1000–1600 km (600–1000 mi)

Avoid prolonged operation above 1/2 throttle.

## 1600 km (1000 mi) and beyond

The vehicle can now be operated normally.

ECA10270

### **NOTICE**

**If any engine trouble should occur during the engine break-in period, immediately have a Yamaha dealer check the vehicle.**

EAU17171

## Parking

When parking, stop the engine, remove the key from the main switch, and then turn the fuel cock lever to “OFF”.

EWA10311

### **WARNING**

- Since the engine and exhaust system can become very hot, park in a place where pedestrians or children are not likely to touch them and be burned.
- Do not park on a slope or on soft ground, otherwise the vehicle may overturn, increasing the risk of a fuel leak and fire.
- Do not park near grass or other flammable materials which might catch fire.

# PERIODIC MAINTENANCE AND ADJUSTMENT

EAU17232

Periodic inspection, adjustment, and lubrication will keep your vehicle in the safest and most efficient condition possible. Safety is an obligation of the vehicle owner/operator. The most important points of vehicle inspection, adjustment, and lubrication are explained on the following pages.

EWA10321

## **WARNING**

**Failure to properly maintain the vehicle or performing maintenance activities incorrectly may increase your risk of injury or death during service or while using the vehicle. If you are not familiar with vehicle service, have a Yamaha dealer perform service.**

EWA15121

## **WARNING**

**Turn off the engine when performing maintenance unless otherwise specified.**

- **A running engine has moving parts that can catch on body parts or clothing and electrical**

**parts that can cause shocks or fires.**

- **Running the engine while servicing can lead to eye injury, burns, fire, or carbon monoxide poisoning – possibly leading to death. See page 2-1 for more information about carbon monoxide.**

EAU17302

Emission controls not only function to ensure cleaner air, but are also vital to proper engine operation and maximum performance. In the following periodic maintenance charts, the services related to emissions control are grouped separately. These services require specialized data, knowledge, and equipment. Maintenance, replacement, or repair of the emission control devices and systems may be performed by any repair establishment or individual that is certified (if applicable). Yamaha dealers are trained and equipped to perform these particular services.

# PERIODIC MAINTENANCE AND ADJUSTMENT

---

EAU17341

## Owner's tool kit

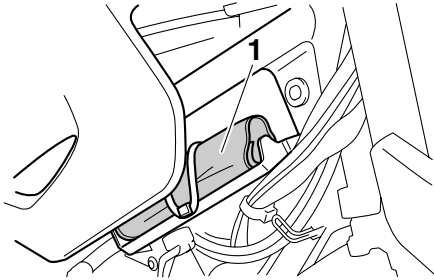

1. Owner's tool kit

The owner's tool kit is located behind panel B. (See page 7-9.)

The service information included in this manual and the tools provided in the owner's tool kit are intended to assist you in the performance of preventive maintenance and minor repairs. However, additional tools such as a torque wrench may be necessary to perform certain maintenance work correctly.

### **TIP** \_\_\_\_\_

If you do not have the tools or experience required for a particular job, have a Yamaha dealer perform it for you.

---



# PERIODIC MAINTENANCE AND ADJUSTMENT

EAU17580

## Periodic maintenance chart for the emission control system

No.	ITEM	ROUTINE	INITIAL	ODOMETER READINGS					
			600 mi (1000 km) or 1 month	4000 mi (6000 km) or 6 months	7000 mi (11000 km) or 12 months	10000 mi (16000 km) or 18 months	13000 mi (21000 km) or 24 months	16000 mi (26000 km) or 30 months	
1	*	<b>Fuel line</b>	<ul style="list-style-type: none"> <li>Check fuel hoses for cracks or damage.</li> <li>Replace if necessary.</li> </ul>		✓	✓	✓	✓	✓
2		<b>Spark plug</b>	<ul style="list-style-type: none"> <li>Check condition.</li> <li>Adjust gap and clean.</li> <li>Replace at 7000 mi (11000 km) or 12 months and thereafter every 6000 mi (10000 km) or 12 months.</li> </ul>		✓	Replace.	✓	Replace.	✓
3		<b>Spark arrester</b>	<ul style="list-style-type: none"> <li>Clean.</li> </ul>		✓	✓	✓	✓	✓
4	*	<b>Valve clearance</b>	<ul style="list-style-type: none"> <li>Check and adjust valve clearance when engine is cold.</li> </ul>	✓	✓	✓	✓	✓	✓
5	*	<b>Crankcase breather system</b>	<ul style="list-style-type: none"> <li>Check breather hose for cracks or damage.</li> <li>Replace if necessary.</li> </ul>		✓	✓	✓	✓	✓
6	*	<b>Idle speed</b>	<ul style="list-style-type: none"> <li>Check and adjust engine idle speed.</li> </ul>		✓	✓	✓	✓	✓
7	*	<b>Exhaust system</b>	<ul style="list-style-type: none"> <li>Check for leakage.</li> <li>Tighten if necessary.</li> <li>Replace gasket(s) if necessary.</li> </ul>		✓	✓	✓	✓	✓
8	*	<b>Evaporative emission control system (for California only)</b>	<ul style="list-style-type: none"> <li>Check control system for damage.</li> <li>Replace if necessary.</li> </ul>			✓		✓	

# PERIODIC MAINTENANCE AND ADJUSTMENT

No.	ITEM	ROUTINE	INITIAL	ODOMETER READINGS					
			600 mi (1000 km) or 1 month	4000 mi (6000 km) or 6 months	7000 mi (11000 km) or 12 months	10000 mi (16000 km) or 18 months	13000 mi (21000 km) or 24 months	16000 mi (26000 km) or 30 months	
9	*	<b>Air induction system</b>	<ul style="list-style-type: none"> <li>• Check the air cut-off valve, reed valve, and hose for damage.</li> <li>• Replace any damaged parts.</li> </ul>			√		√	

\* Since these items require special tools, data and technical skills, have a Yamaha dealer perform the service.

# PERIODIC MAINTENANCE AND ADJUSTMENT

EAU32164

## General maintenance and lubrication chart

No.	ITEM	ROUTINE	INITIAL	ODOMETER READINGS					
			600 mi (1000 km) or 1 month	4000 mi (6000 km) or 6 months	7000 mi (11000 km) or 12 months	10000 mi (16000 km) or 18 months	13000 mi (21000 km) or 24 months	16000 mi (26000 km) or 30 months	
1	*	<b>Air filter element</b>	<ul style="list-style-type: none"> <li>Check condition and for damage, and replace if necessary.</li> </ul>		✓	✓	✓	✓	✓
			<ul style="list-style-type: none"> <li>Replace.</li> </ul>					✓	
2	*	<b>Clutch</b>	<ul style="list-style-type: none"> <li>Check operation.</li> <li>Adjust or replace cable.</li> </ul>	✓	✓	✓	✓	✓	✓
3	*	<b>Front brake</b>	<ul style="list-style-type: none"> <li>Check operation, fluid level, and for fluid leakage.</li> <li>Replace brake pads if necessary.</li> </ul>	✓	✓	✓	✓	✓	✓
4	*	<b>Rear brake</b>	<ul style="list-style-type: none"> <li>Check operation, fluid level, and for fluid leakage.</li> <li>Replace brake pads if necessary.</li> </ul>	✓	✓	✓	✓	✓	✓
5	*	<b>Brake hose</b>	<ul style="list-style-type: none"> <li>Check for cracks or damage.</li> </ul>		✓	✓	✓	✓	✓
			<ul style="list-style-type: none"> <li>Replace.</li> </ul>	Every 4 years					
6	*	<b>Wheels</b>	<ul style="list-style-type: none"> <li>Check runout, spoke tightness and for damage.</li> <li>Tighten spokes if necessary.</li> </ul>		✓	✓	✓	✓	✓
7	*	<b>Tires</b>	<ul style="list-style-type: none"> <li>Check tread depth and for damage.</li> <li>Replace if necessary.</li> <li>Check air pressure.</li> <li>Correct if necessary.</li> </ul>		✓	✓	✓	✓	✓
8	*	<b>Wheel bearings</b>	<ul style="list-style-type: none"> <li>Check bearings for smooth operation.</li> <li>Replace if necessary.</li> </ul>		✓	✓	✓	✓	✓

7

# PERIODIC MAINTENANCE AND ADJUSTMENT

No.	ITEM	ROUTINE	INITIAL	ODOMETER READINGS				
			600 mi (1000 km) or 1 month	4000 mi (6000 km) or 6 months	7000 mi (11000 km) or 12 months	10000 mi (16000 km) or 18 months	13000 mi (21000 km) or 24 months	16000 mi (26000 km) or 30 months
9	* <b>Swingarm pivot bushes</b>	<ul style="list-style-type: none"> <li>• Check bush assemblies for looseness.</li> <li>• Lubricate with lithium-soap-based grease.</li> </ul>		√	√	√	√	√
10	<b>Drive chain</b>	<ul style="list-style-type: none"> <li>• Check chain slack, alignment and condition.</li> <li>• Adjust and lubricate chain with a special O-ring chain lubricant thoroughly.</li> </ul>	Every 300 mi (500 km) and after washing the motorcycle or riding in the rain					
11	* <b>Steering bearings</b>	<ul style="list-style-type: none"> <li>• Check bearing assemblies for looseness.</li> <li>• Moderately repack with lithium-soap-based grease.</li> </ul>	√	√	√	√	Repack.	√
12	* <b>Chassis fasteners</b>	<ul style="list-style-type: none"> <li>• Check all chassis fitting and fasteners.</li> <li>• Correct if necessary.</li> </ul>		√	√	√	√	√
13	<b>Brake lever pivot shaft</b>	<ul style="list-style-type: none"> <li>• Apply silicone grease lightly.</li> </ul>		√	√	√	√	√
14	<b>Brake pedal pivot shaft</b>	<ul style="list-style-type: none"> <li>• Apply lithium-soap-based grease lightly.</li> </ul>		√	√	√	√	√
15	<b>Clutch lever pivot shaft</b>	<ul style="list-style-type: none"> <li>• Apply lithium-soap-based grease lightly.</li> </ul>		√	√	√	√	√
16	<b>Shift pedal pivot shaft</b>	<ul style="list-style-type: none"> <li>• Apply lithium-soap-based grease lightly.</li> </ul>		√	√	√	√	√
17	<b>Sidestand pivot</b>	<ul style="list-style-type: none"> <li>• Check operation.</li> <li>• Apply lithium-soap-based grease lightly.</li> </ul>		√	√	√	√	√
18	* <b>Sidestand switch</b>	<ul style="list-style-type: none"> <li>• Check operation and replace if necessary.</li> </ul>	√	√	√	√	√	√

# PERIODIC MAINTENANCE AND ADJUSTMENT

No.	ITEM	ROUTINE	INITIAL	ODOMETER READINGS					
			600 mi (1000 km) or 1 month	4000 mi (6000 km) or 6 months	7000 mi (11000 km) or 12 months	10000 mi (16000 km) or 18 months	13000 mi (21000 km) or 24 months	16000 mi (26000 km) or 30 months	
19	*	<b>Front fork</b>	<ul style="list-style-type: none"> <li>• Check operation and for oil leakage.</li> <li>• Replace if necessary.</li> </ul>		√	√	√	√	√
20	*	<b>Shock absorber assembly</b>	<ul style="list-style-type: none"> <li>• Check operation and for oil leakage.</li> <li>• Replace if necessary.</li> </ul>		√	√	√	√	√
21	*	<b>Rear suspension link pivots</b>	<ul style="list-style-type: none"> <li>• Check operation.</li> <li>• Correct if necessary.</li> </ul>			√		√	
22		<b>Engine oil</b>	<ul style="list-style-type: none"> <li>• Change (warm engine before draining).</li> </ul>	√	√	√	√	√	√
23		<b>Engine oil filter element</b>	<ul style="list-style-type: none"> <li>• Replace.</li> </ul>	√		√		√	
24	*	<b>Front and rear brake switches</b>	<ul style="list-style-type: none"> <li>• Check operation.</li> </ul>	√	√	√	√	√	√
25	*	<b>Control cables</b>	<ul style="list-style-type: none"> <li>• Apply Yamaha chain and cable lube or engine oil thoroughly.</li> </ul>	√	√	√	√	√	√
26	*	<b>Throttle grip housing and cable</b>	<ul style="list-style-type: none"> <li>• Check operation and free play.</li> <li>• Adjust the throttle cable free play if necessary.</li> <li>• Lubricate the throttle grip housing and cable.</li> </ul>		√	√	√	√	√
27	*	<b>Lights, signals and switches</b>	<ul style="list-style-type: none"> <li>• Check operation.</li> <li>• Adjust headlight beam.</li> </ul>	√	√	√	√	√	√

\* Since these items require special tools, data and technical skills, have a Yamaha dealer perform the service.

## TIP

From 19000 mi (31000 km) or 36 months, repeat the maintenance intervals starting from 7000 mi (11000 km) or 12 months.

# PERIODIC MAINTENANCE AND ADJUSTMENT

---

---

EAU17650

## TIP

---

- Air filter
    - This model's air filter is equipped with a disposable oil-coated paper element, which must not be cleaned with compressed air to avoid damaging it.
    - The air filter element needs to be replaced more frequently when riding in unusually wet or dusty areas.
  - Hydraulic brake service
    - After disassembling the brake master cylinders and calipers, always change the fluid. Regularly check the brake fluid levels and fill the reservoirs as required.
    - Every two years replace the internal components of the brake master cylinders and calipers, and change the brake fluid.
    - Replace the brake hoses every four years and if cracked or damaged.
-

# PERIODIC MAINTENANCE AND ADJUSTMENT

EAU18722

## Removing and installing the cowling and panels

The cowling and panels shown need to be removed to perform some of the maintenance jobs described in this chapter. Refer to this section each time the cowling or a panel needs to be removed and installed.

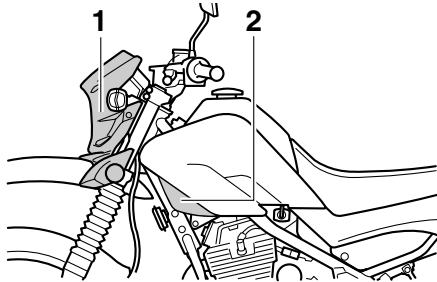

1. Cowling A
2. Panel A

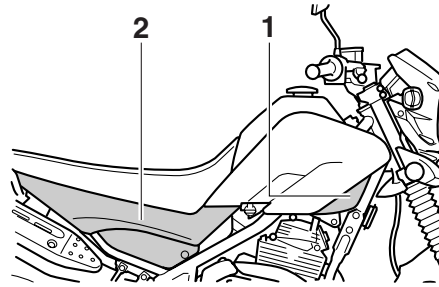

1. Panel B
2. Panel C

## Cowling A

### To remove the cowling

1. Remove the bolts.

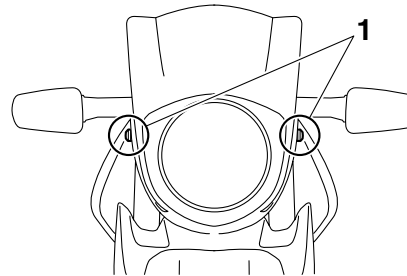

1. Bolt

2. Unhook both projections at the bottom of the cowling by pulling it downward, and then pull the cowling forward as shown.

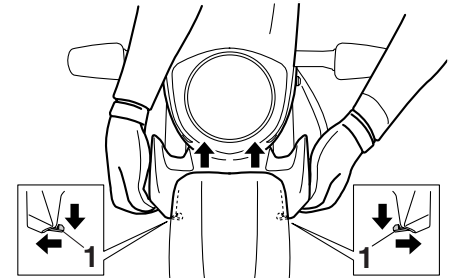

EAU44841

1. Projection

### To install the cowling

1. Place the cowling in the original position.
2. Install the bolts.

EAU44850

## Panels A and B

### To remove one of the panels

1. Remove the screw and collar.

# PERIODIC MAINTENANCE AND ADJUSTMENT

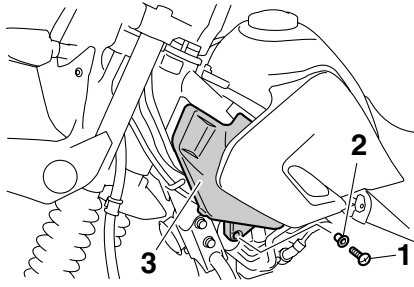

1. Screw
2. Collar
3. Panel A

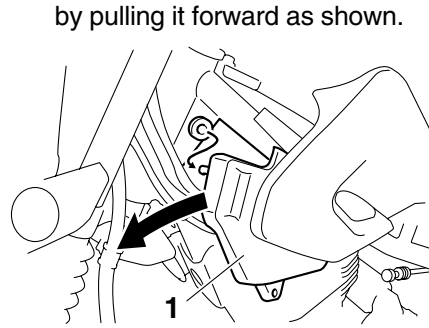

1. Panel A

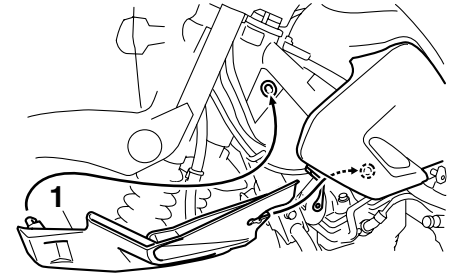

1. Panel A

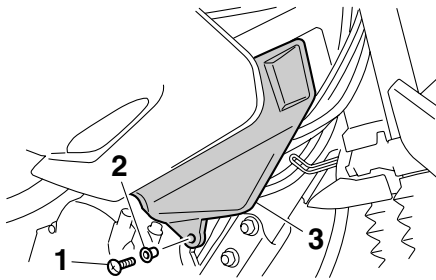

1. Screw
2. Collar
3. Panel B

2. Pull the front part of the panel outward, and then remove the panel

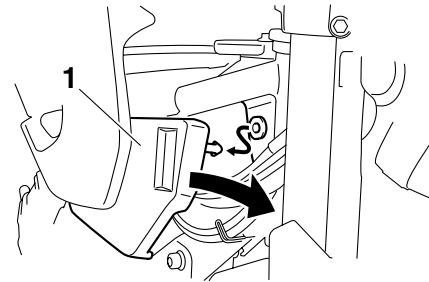

1. Panel B

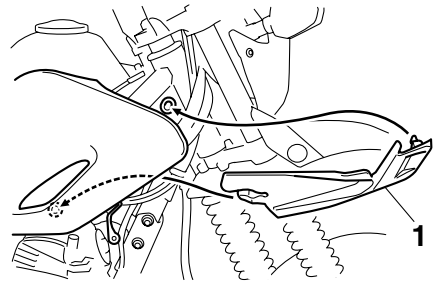

1. Panel B

## To install the panel

Place the collar and panel in their original position, and then install the screw.

## **Panel C**

### To remove the panel

1. Remove the seat. (See page 4-10.)



# PERIODIC MAINTENANCE AND ADJUSTMENT

EAU19603

2. Remove the bolt and washer, and then remove the panel as shown.

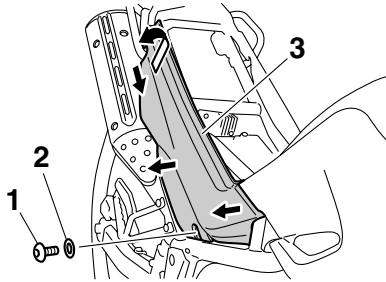

1. Bolt
2. Washer
3. Panel C

## To install the panel

1. Place the panel in the original position, and then install the washer and bolt.

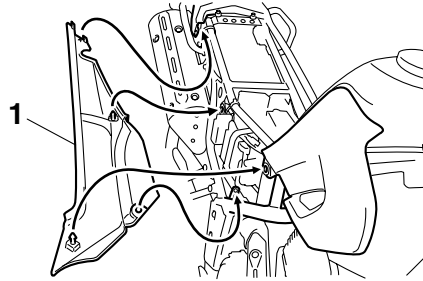

1. Panel C
2. Install the seat.

## Checking the spark plug

The spark plug is an important engine component, which is easy to check. Since heat and deposits will cause any spark plug to slowly erode, the spark plug should be removed and checked in accordance with the periodic maintenance and lubrication chart. In addition, the condition of the spark plug can reveal the condition of the engine.

## To remove the spark plug

1. Remove the spark plug cap.

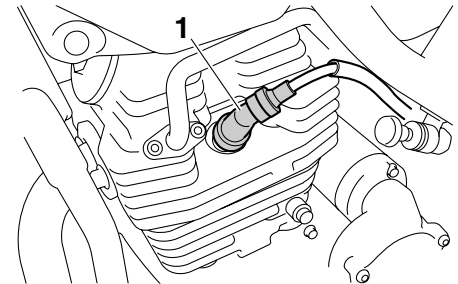

1. Spark plug cap
2. Remove the spark plug as shown, with the spark plug wrench included in the owner's tool kit.

# PERIODIC MAINTENANCE AND ADJUSTMENT

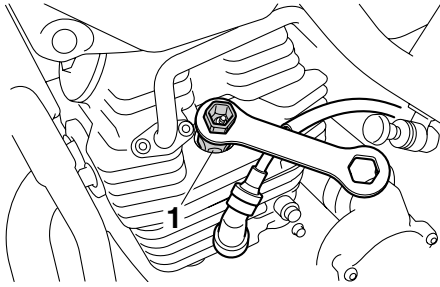

1. Spark plug wrench

## To check the spark plug

1. Check that the porcelain insulator around the center electrode of the spark plug is a medium-to-light tan (the ideal color when the vehicle is ridden normally).

7

## TIP

If the spark plug shows a distinctly different color, the engine could be operating improperly. Do not attempt to diagnose such problems yourself. Instead, have a Yamaha dealer check the vehicle.

2. Check the spark plug for electrode erosion and excessive carbon or other deposits, and replace

it if necessary.

**Specified spark plug:**  
NGK/DR7EA

## To install the spark plug

1. Measure the spark plug gap with a wire thickness gauge and, if necessary, adjust the gap to specification.

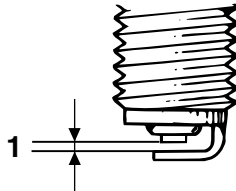

1. Spark plug gap

**Spark plug gap:**  
0.6–0.7 mm (0.024–0.028 in)

2. Clean the surface of the spark plug gasket and its mating surface, and then wipe off any grime from the spark plug threads.

3. Install the spark plug with the spark plug wrench, and then tighten it to the specified torque.

## Tightening torque:

Spark plug:  
18 Nm (1.8 m·kgf, 13.0 ft·lbf)

## TIP

If a torque wrench is not available when installing a spark plug, a good estimate of the correct torque is 1/4–1/2 turn past finger tight. However, the spark plug should be tightened to the specified torque as soon as possible.

4. Install the spark plug cap.

# PERIODIC MAINTENANCE AND ADJUSTMENT

EAU19681

## Canister (for California only)

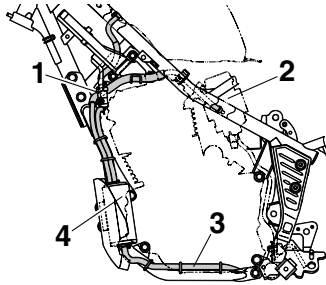

1. Rollover valve
2. Carburetor
3. Canister breather
4. Canister

This model is equipped with a canister to prevent the discharging of fuel vapor into the atmosphere. Before operating this vehicle, make sure to check the following:

- Check each hose connection.
- Check each hose and canister for cracks or damage. Replace if damaged.
- Make sure that the canister breather is not blocked, and if necessary, clean it.

EAU37804

## Engine oil and oil filter element

The engine oil level should be checked before each ride. In addition, the oil must be changed and the oil filter element replaced at the intervals specified in the General periodic maintenance and lubrication chart.

### To check the engine oil level

1. Place the vehicle on a level surface and hold it in an upright position. A slight tilt to the side can result in a false reading.
2. Start the engine, warm it up for several minutes, and then turn it off.
3. Wait a few minutes until the oil settles, and then check the oil level through the check window located at the bottom-right side of the crankcase.

### TIP

The engine oil should be between the minimum and maximum level marks.

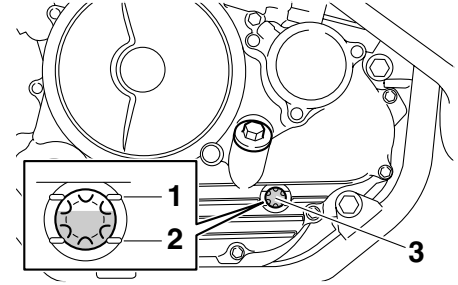

1. Maximum level mark
2. Minimum level mark
3. Engine oil level check window

4. If the engine oil is below the minimum level mark, add sufficient oil of the recommended type to raise it to the correct level.

### To change the engine oil (with or without oil filter element replacement)

1. Place the vehicle on a level surface.
2. Start the engine, warm it up for several minutes, and then turn it off.
3. Place an oil pan under the engine to collect the used oil.

# PERIODIC MAINTENANCE AND ADJUSTMENT

4. Remove the engine oil filler bolt and drain bolt to drain the oil from the crankcase.

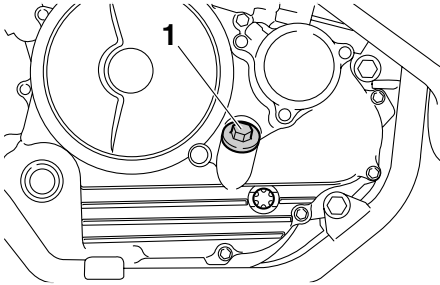

1. Engine oil filler bolt

place it if necessary.

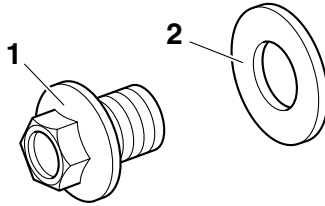

1. Engine oil drain bolt  
2. Washer

5. Remove the oil filter element drain bolt to drain the oil from the oil filter element.

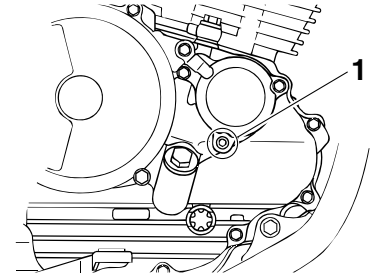

1. Oil filter element drain bolt

## TIP

Skip steps 6–8 if the oil filter element is not being replaced.

6. Remove the oil filter element cover by removing the bolts.

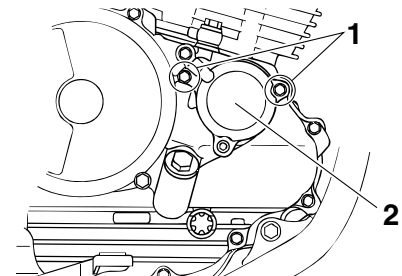

1. Oil filter element cover bolt  
2. Oil filter element cover

7

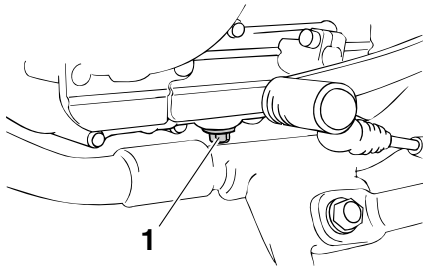

1. Engine oil drain bolt

## TIP

Check the washer for damage and re-

# PERIODIC MAINTENANCE AND ADJUSTMENT

- Remove and replace the oil filter element and O-rings.

## TIP

Make sure that the O-rings are properly seated.

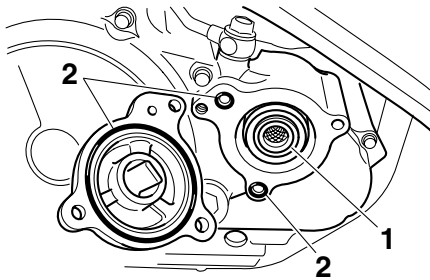

- Oil filter element
- O-ring

- Install the oil filter element cover by installing the bolts, then tightening them to the specified torque.

## Tightening torque:

Oil filter element cover bolt:  
10 Nm (1.0 m·kgf, 7.2 ft·lbf)

- Install the engine oil drain bolt, and then tighten it to the specified torque.

- Install the oil filter element drain bolt, and then tighten it to the specified torque.

## Tightening torques:

Engine oil drain bolt:  
20 Nm (2.0 m·kgf, 14.5 ft·lbf)  
Oil filter element drain bolt:  
10 Nm (1.0 m·kgf, 7.2 ft·lbf)

- Refill with the specified amount of the recommended engine oil, and then install and tighten the oil filler bolt.

## Recommended oil:

See page 9-1.

## Oil quantity:

Without oil filter element replacement:  
1.20 L (1.27 US qt, 1.06 Imp.qt)  
With oil filter element replacement:  
1.30 L (1.37 US qt, 1.14 Imp.qt)

## TIP

Be sure to wipe off spilled oil on any parts after the engine and exhaust system have cooled down.

page (since the engine oil also lubricates the clutch), do not mix any chemical additives. Do not use oils with a diesel specification of “CD” or oils of a higher quality than specified. In addition, do not use oils labeled “ENERGY CONSERVING II” or higher.

- Make sure that no foreign material enters the crankcase.
- Start the engine, and then let it idle for several minutes while checking it for oil leakage. If oil is leaking, immediately turn the engine off and check for the cause.
  - Turn the engine off, and then check the oil level and correct it if necessary.

## NOTICE

- In order to prevent clutch slip-

ECA11620

# PERIODIC MAINTENANCE AND ADJUSTMENT

EAU44651

## Replacing the air filter element and cleaning the check hose

The air filter element should be replaced at the intervals specified in the periodic maintenance and lubrication chart. Replace the air filter element more frequently if you are riding in unusually wet or dusty areas. In addition, the air filter check hose must be frequently checked and cleaned if necessary.

### To replace the air filter element

1. Remove the seat. (See page 4-10.)
2. Remove the air filter case cover by removing the screws.

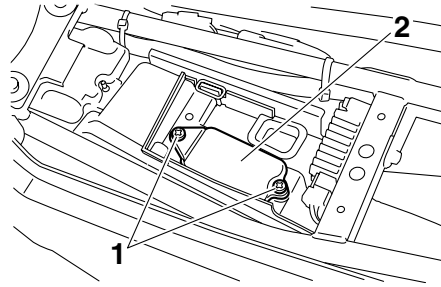

1. Screw
2. Air filter case cover
3. Pull the air filter element out.

4. Insert a new air filter element into the air filter case as shown.

**NOTICE:** Make sure that the air filter element is properly seated in the air filter case. The engine should never be operated without the air filter element installed, otherwise the piston(s) and/or cylinder(s) may become excessively worn.<sup>[ECA10481]</sup>

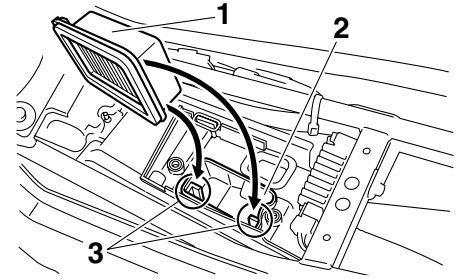

1. Air filter element
2. Air filter case
3. Slot
5. Install the air filter case cover by installing the screws.
6. Install the seat.

# PERIODIC MAINTENANCE AND ADJUSTMENT

## To clean the air filter check hose

1. Check the hose on the side of the air filter case for accumulated dirt or water.

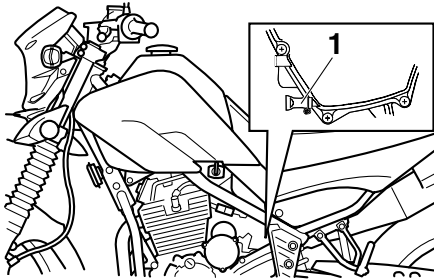

1. Air filter check hose
2. If dirt or water is visible, remove the hose, clean it, and then install it.

## Cleaning the spark arrester

EAU41221

The spark arrester should be cleaned at the intervals specified in the periodic maintenance and lubrication chart.

EWA10980

### **⚠ WARNING**

- Always let the exhaust system cool prior to touching exhaust components.
- Do not start the engine when cleaning the exhaust system.

1. Remove the tailpipe by removing the screw, and then pulling it out of the muffler.

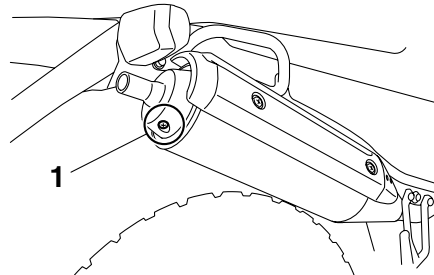

1. Screw

2. Tap the tailpipe lightly, and then use a wire brush to remove any

carbon deposits from the spark arrester portion of the tailpipe and inside of the tailpipe housing.

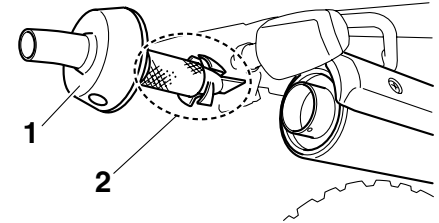

1. Tailpipe
2. Spark arrester

3. Insert the tailpipe into the muffler, and then install and tighten the screw.

### **TIP**

Make sure to align the screw hole when inserting the tailpipe.

# PERIODIC MAINTENANCE AND ADJUSTMENT

EAU21251

## Carburetor

The carburetor is an important part of the engine and its emission control system, which requires very sophisticated adjustment. Therefore, carburetor adjustments should be left to Yamaha dealer, who has the necessary professional knowledge and experience.

EAU44734

## Checking the engine idling speed

Check the engine idling speed and, if necessary, have it corrected by a Yamaha dealer.

**Engine idling speed:**  
1300–1500 r/min

EAU21382

## Checking the throttle cable free play

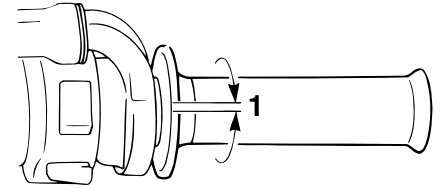

### 1. Throttle cable free play

The throttle cable free play should measure 3.0–5.0 mm (0.12–0.20 in) at the throttle grip. Periodically check the throttle cable free play and, if necessary, have a Yamaha dealer adjust it.



# PERIODIC MAINTENANCE AND ADJUSTMENT

EAU21401

## Valve clearance

The valve clearance changes with use, resulting in improper air-fuel mixture and/or engine noise. To prevent this from occurring, the valve clearance must be adjusted by a Yamaha dealer at the intervals specified in the periodic maintenance and lubrication chart.

EAU21602

## Tires

To maximize the performance, durability, and safe operation of your motorcycle, note the following points regarding the specified tires.

### Tire air pressure

The tire air pressure should be checked and, if necessary, adjusted before each ride.

EWA10501



**WARNING**

Operation of this vehicle with improper tire pressure may cause severe injury or death from loss of control.

- The tire air pressure must be checked and adjusted on cold tires (i.e., when the temperature of the tires equals the ambient temperature).
- The tire air pressure must be adjusted in accordance with the riding speed and with the total weight of rider, passenger, cargo, and accessories approved for this model.

### Tire air pressure (measured on cold tires):

#### 0–90 kg (0–198 lb):

Front:

125 kPa (1.25 kgf/cm<sup>2</sup>, 18 psi)

Rear:

150 kPa (1.50 kgf/cm<sup>2</sup>, 22 psi)

#### 90–160 kg (198–353 lb):

Front:

150 kPa (1.50 kgf/cm<sup>2</sup>, 22 psi)

Rear:

175 kPa (1.75 kgf/cm<sup>2</sup>, 25 psi)

#### Maximum load\*:

160 kg (353 lb)

\* Total weight of rider, passenger, cargo and accessories

EWA10511



**WARNING**

Never overload your vehicle. Operation of an overloaded vehicle could cause an accident.

# PERIODIC MAINTENANCE AND ADJUSTMENT

## Tire inspection

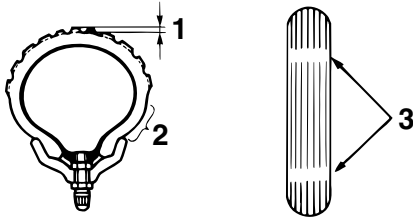

1. Tire tread depth
2. Tire sidewall
3. Tire wear indicator

The tires must be checked before each ride. If the tire shows crosswise lines (minimum tread depth), if the tire has a nail or glass fragments in it, or if the sidewall is cracked, have a Yamaha dealer replace the tire immediately.

**Minimum tire tread depth (front and rear):**

1.0 mm (0.04 in)

## TIP

The tire tread depth limits may differ from country to country. Always comply with the local regulations.

## Tire information

This motorcycle is equipped with tube tires.

EWA10461

## WARNING

The front and rear tires should be of the same make and design, otherwise the handling characteristics of the vehicle may be different, which could lead to an accident.

After extensive tests, only the tires listed below have been approved for this model by Yamaha Motor Co., Ltd.

### Front tire:

Size:

2.75-21 45P

Manufacturer/model:

BRIDGESTONE/TW-301

### Rear tire:

Size:

120/80-18M/C 62P

Manufacturer/model:

BRIDGESTONE/TW-302F

EWA10561

## WARNING

- It is dangerous to ride with a worn-out tire. When a tire tread begins to show crosswise lines, have a Yamaha dealer replace the tire immediately.
- The replacement of all wheel and brake-related parts, including the tires, should be left to a Yamaha dealer, who has the necessary professional knowledge and experience.
- It is not recommended to patch a punctured tube. If unavoidable, however, patch the tube very carefully and replace it as soon as possible with a high-quality product.

# PERIODIC MAINTENANCE AND ADJUSTMENT

## Spoke wheels

EAU21941

EWA10610



### WARNING

The wheels on this model are not designed for use with tubeless tires. Do not attempt to use tubeless tires on this model.

To maximize the performance, durability, and safe operation of your motorcycle, note the following points regarding the specified wheels.

- The wheel rims should be checked for cracks, bends or warpage, and the spokes for looseness or damage before each ride. If any damage is found, have a Yamaha dealer replace the wheel. Do not attempt even the smallest repair to the wheel. A deformed or cracked wheel must be replaced.
- The wheel should be balanced whenever either the tire or wheel has been changed or replaced. An unbalanced wheel can result in poor performance, adverse handling characteristics, and a shortened tire life.

- Ride at moderate speeds after changing a tire since the tire surface must first be “broken in” for it to develop its optimal characteristics.

## Adjusting the clutch lever free play

EAU22034

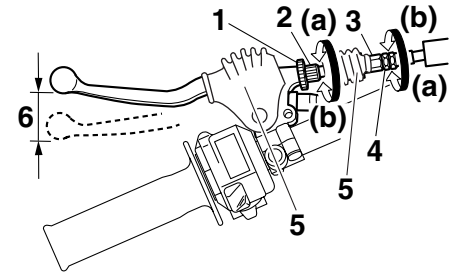

1. Locknut (clutch lever)
2. Adjusting bolt
3. Adjusting nut
4. Locknut (clutch cable)
5. Rubber cover
6. Clutch lever free play

The clutch lever free play should measure 10.0–15.0 mm (0.39–0.59 in) as shown. Periodically check the clutch lever free play and, if necessary, adjust it as follows.

1. Slide the rubber cover back at the clutch lever.
2. Loosen the locknut.
3. To increase the clutch lever free

# PERIODIC MAINTENANCE AND ADJUSTMENT

play, turn the clutch lever free play adjusting bolt in direction (a). To decrease the clutch lever free play, turn the adjusting bolt in direction (b).

## TIP

If the specified clutch lever free play could be obtained as described above, skip steps 4–7.

4. Fully turn the adjusting bolt in direction (a) to loosen the clutch cable.
5. Loosen the locknut further down the clutch cable.
6. To increase the clutch lever free play, turn the clutch lever free play adjusting nut in direction (a). To decrease the clutch lever free play, turn the adjusting nut in direction (b).
7. Tighten the locknut at the clutch cable.
8. Tighten the locknut at the clutch lever, and then slide the rubber cover to its original position.

## Adjusting the brake lever free play

EAU22093

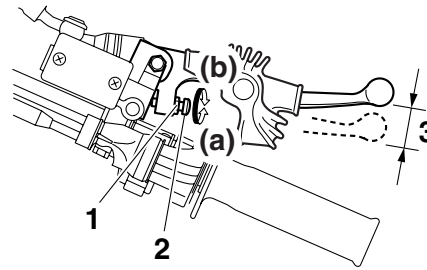

1. Locknut
2. Brake lever free play adjusting screw
3. Brake lever free play

The brake lever free play should measure 2.0–5.0 mm (0.08–0.20 in) as shown. Periodically check the brake lever free play and, if necessary, adjust it as follows.

1. Loosen the locknut at the brake lever.
2. To increase the brake lever free play, turn the brake lever free play adjusting screw in direction (a). To decrease the brake lever free play, turn the adjusting screw in

- direction (b).
3. Tighten the locknut.

EWA10630

## WARNING

- After adjusting the brake lever free play, check the free play and make sure that the brake is working properly.
- A soft or spongy feeling in the brake lever can indicate the presence of air in the hydraulic system. If there is air in the hydraulic system, have a Yamaha dealer bleed the system before operating the motorcycle. Air in the hydraulic system will diminish the braking performance, which may result in loss of control and an accident.

# PERIODIC MAINTENANCE AND ADJUSTMENT

## Adjusting the rear brake light switch

EAU22272

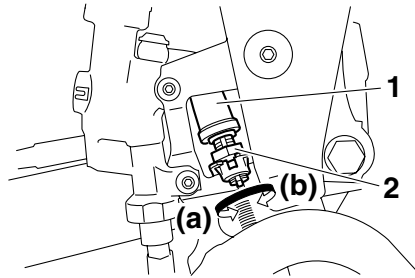

1. Rear brake light switch
2. Adjusting nut

The rear brake light, which is activated by the brake pedal, should come on just before braking takes effect. If necessary, adjust the rear brake light switch as follows.

Turn the rear brake light switch adjusting nut while holding the rear brake light switch in place. To make the brake light come on earlier, turn the adjusting nut in direction (a). To make the brake light come on later, turn the adjusting nut in direction (b).

## Checking the front and rear brake pads

EAU22390

The front and rear brake pads must be checked for wear at the intervals specified in the periodic maintenance and lubrication chart.

### Front brake pads

EAU22420

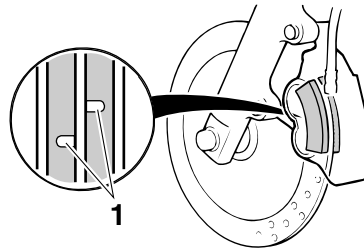

1. Wear indicator groove

Each front brake pad is provided with a wear indicator groove, which allows you to check the brake pad wear without having to disassemble the brake. To check the brake pad wear, check the wear indicator groove. If a brake pad has worn to the point that the wear

indicator groove has almost disappeared, have a Yamaha dealer replace the brake pads as a set.

### Rear brake pads

EAU36720

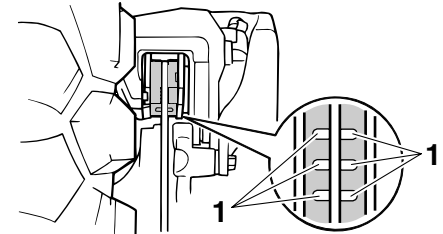

1. Wear indicator groove

Each rear brake pad is provided with wear indicator grooves, which allow you to check the brake pad wear without having to disassemble the brake. To check the brake pad wear, check the wear indicator grooves. If a brake pad has worn to the point that the wear indicator grooves have almost disappeared, have a Yamaha dealer replace the brake pads as a set.

# PERIODIC MAINTENANCE AND ADJUSTMENT

EAU22580

## Checking the brake fluid level

### Front brake

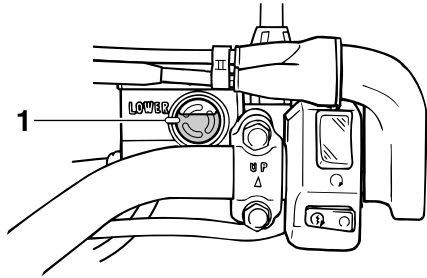

1. Minimum level mark

### Rear brake

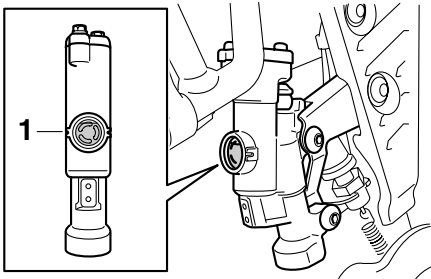

1. Minimum level mark

Insufficient brake fluid may allow air to enter the brake system, possibly caus-

ing it to become ineffective.

Before riding, check that the brake fluid is above the minimum level mark and replenish if necessary. A low brake fluid level may indicate worn brake pads and/or brake system leakage. If the brake fluid level is low, be sure to check the brake pads for wear and the brake system for leakage.

Observe these precautions:

- When checking the fluid level, make sure that the top of the brake fluid reservoir is level.
- Use only the recommended quality brake fluid, otherwise the rubber seals may deteriorate, causing leakage and poor braking performance.

**Recommended brake fluid:**  
DOT 4

- Refill with the same type of brake fluid. Mixing fluids may result in a harmful chemical reaction and lead to poor braking performance.
- Be careful that water does not enter the brake fluid reservoir when refilling. Water will significantly

lower the boiling point of the fluid and may result in vapor lock.

- Brake fluid may deteriorate painted surfaces or plastic parts. Always clean up spilled fluid immediately.
- As the brake pads wear, it is normal for the brake fluid level to gradually go down. However, if the brake fluid level goes down suddenly, have a Yamaha dealer check the cause.

# PERIODIC MAINTENANCE AND ADJUSTMENT

EAU22731

## Changing the brake fluid

Have a Yamaha dealer change the brake fluid at the intervals specified in the TIP after the periodic maintenance and lubrication chart. In addition, have the oil seals of the master cylinders and calipers as well as the brake hoses replaced at the intervals listed below or whenever they are damaged or leaking.

- Oil seals: Replace every two years.
- Brake hoses: Replace every four years.

EAU22760

## Drive chain slack

The drive chain slack should be checked before each ride and adjusted if necessary.

EAU22773

### To check the drive chain slack

1. Place the motorcycle on the side-stand.

### TIP

When checking and adjusting the drive chain slack, there should be no weight on the motorcycle.

2. Shift the transmission into the neutral position.
3. Move the rear wheel by pushing the motorcycle to locate the tightest portion of the drive chain, and then measure the drive chain slack as shown.

**Drive chain slack:**  
40.0–45.0 mm (1.57–1.77 in)

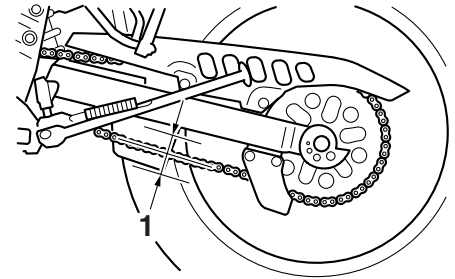

1. Drive chain slack

4. If the drive chain slack is incorrect, adjust it as follows.

EAU22961

### To adjust the drive chain slack

1. Loosen the axle nut.
2. To tighten the drive chain, turn the drive chain slack adjusting plate on each side of the swingarm in direction (a). To loosen the drive chain, turn the adjusting plate on each side of the swingarm in direction (b), and then push the rear wheel forward. **NOTICE: Improper drive chain slack will overload the engine as well as other vital parts of the motorcycle and can lead**

# PERIODIC MAINTENANCE AND ADJUSTMENT

to chain slippage or breakage. To prevent this from occurring, keep the drive chain slack within the specified limits.<sup>[ECA10571]</sup>

**TIP**  
Make sure that both adjusting plates are in the same position for proper wheel alignment.

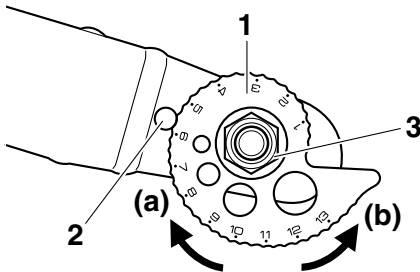

1. Drive chain slack adjusting plate
  2. Stopper
  3. Axle nut
3. Tighten the axle nut to the specified torque.

**Tightening torque:**

Axle nut:  
85 Nm (8.5 m·kgf, 61.5 ft·lbf)

EAU23024

## Cleaning and lubricating the drive chain

The drive chain must be cleaned and lubricated at the intervals specified in the periodic maintenance and lubrication chart, otherwise it will quickly wear out, especially when riding in dusty or wet areas. Service the drive chain as follows.

ECA10582

**NOTICE**

The drive chain must be lubricated after washing the motorcycle and riding in the rain or wet areas.

1. Clean the drive chain with kerosene and a small soft brush.  
**NOTICE:** To prevent damaging the O-rings, do not clean the drive chain with steam cleaners, high-pressure washers or inappropriate solvents.<sup>[ECA11121]</sup>
2. Wipe the drive chain dry.
3. Thoroughly lubricate the drive chain with a special O-ring chain lubricant. **NOTICE:** Do not use engine oil or any other lubricants for the drive chain, as they

may contain substances that could damage the O-rings.<sup>[ECA11111]</sup>



# PERIODIC MAINTENANCE AND ADJUSTMENT

EAU23093

## Checking and lubricating the cables

The operation of all control cables and the condition of the cables should be checked before each ride, and the cables and cable ends should be lubricated if necessary. If a cable is damaged or does not move smoothly, have a Yamaha dealer check or replace it. **WARNING! Damage to the outer housing of cables may result in internal rusting and cause interference with cable movement. Replace damaged cables as soon as possible to prevent unsafe conditions.**<sup>[EWA10711]</sup>

### Recommended lubricant:

Yamaha Chain and Cable Lube or engine oil

EAU23111

## Checking and lubricating the throttle grip and cable

The operation of the throttle grip should be checked before each ride. In addition, the cable should be lubricated at the intervals specified in the periodic maintenance chart.

EAU44271

## Checking and lubricating the brake and shift pedals

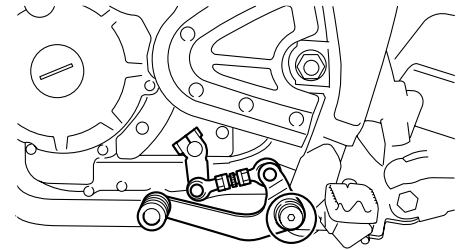
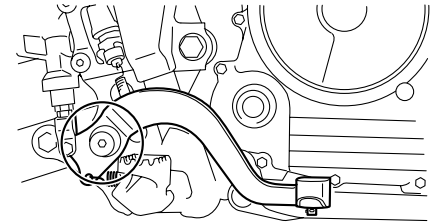

The operation of the brake and shift pedals should be checked before each ride, and the pedal pivots should be lubricated if necessary.

# PERIODIC MAINTENANCE AND ADJUSTMENT

**Recommended lubricant:**  
Lithium-soap-based grease

## Checking and lubricating the brake and clutch levers

EAU23142

### Brake lever

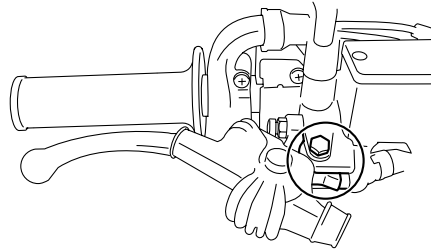

### Clutch lever

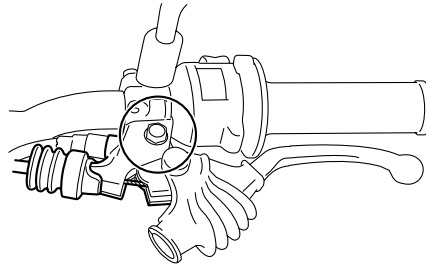

### Recommended lubricants:

Brake lever:

Silicone grease

Clutch lever:

Lithium-soap-based grease

The operation of the brake and clutch levers should be checked before each ride, and the lever pivots should be lubricated if necessary.

EAU23202

## Checking and lubricating the sidestand

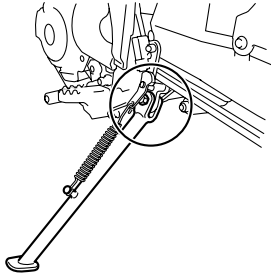

The operation of the sidestand should be checked before each ride, and the sidestand pivot and metal-to-metal contact surfaces should be lubricated if necessary.

EWA10731

### **WARNING**

**If the sidestand does not move up and down smoothly, have a Yamaha dealer check or repair it. Otherwise, the sidestand could contact the ground and distract the operator, resulting in a possible loss of control.**

**Recommended lubricant:**  
Lithium-soap-based grease

EAU23250

## Lubricating the rear suspension

The pivoting points of the rear suspension must be lubricated at the intervals specified in the periodic maintenance and lubrication chart.

**Recommended lubricant:**  
Lithium-soap-based grease

EAU23272

## Checking the front fork

The condition and operation of the front fork must be checked as follows at the intervals specified in the periodic maintenance and lubrication chart.

### To check the condition

Check the inner tubes for scratches, damage and excessive oil leakage.

### To check the operation

1. Place the vehicle on a level surface and hold it in an upright position. **WARNING! To avoid injury, securely support the vehicle so there is no danger of it falling over.** [EWA10751]
2. While applying the front brake, push down hard on the handlebars several times to check if the front fork compresses and rebounds smoothly.

# PERIODIC MAINTENANCE AND ADJUSTMENT

EAU23263

EAU23290

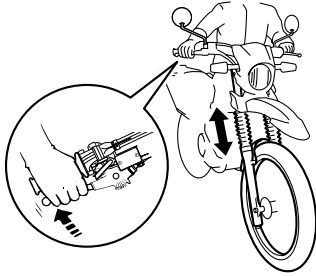

ECA10590

## NOTICE

If any damage is found or the front fork does not operate smoothly, have a Yamaha dealer check or repair it.

## Checking the steering

Worn or loose steering bearings may cause danger. Therefore, the operation of the steering must be checked as follows at the intervals specified in the periodic maintenance and lubrication chart.

1. Place a stand under the engine to raise the front wheel off the ground. (See page 7-35 for more information.) **WARNING! To avoid injury, securely support the vehicle so there is no danger of it falling over.**<sup>[EWA10751]</sup>
2. Hold the lower ends of the front fork legs and try to move them forward and backward. If any free play can be felt, have a Yamaha dealer check or repair the steering.

## Checking the wheel bearings

The front and rear wheel bearings must be checked at the intervals specified in the periodic maintenance and lubrication chart. If there is play in the wheel hub or if the wheel does not turn smoothly, have a Yamaha dealer check the wheel bearings.

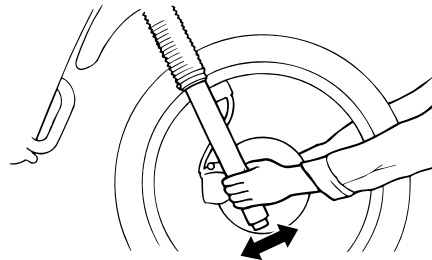

# PERIODIC MAINTENANCE AND ADJUSTMENT

## Battery

EAU23395

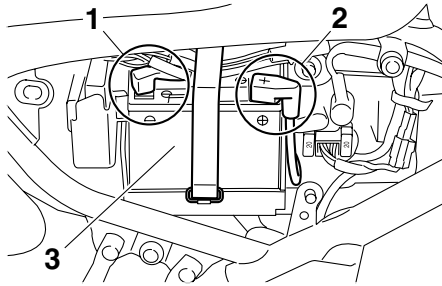

1. Negative battery lead (black)
2. Positive battery lead (red)
3. Battery

The battery is located behind panel C. (See page 7-9.)

This model is equipped with a VRLA (Valve Regulated Lead Acid) battery. There is no need to check the electrolyte or to add distilled water. However, the battery coupler needs to be checked and, if necessary, securely fastened.

EWA10760

### **WARNING**

- **Electrolyte is poisonous and dangerous since it contains sul-**

**furic acid, which causes severe burns. Avoid any contact with skin, eyes or clothing and always shield your eyes when working near batteries. In case of contact, administer the following FIRST AID.**

- **EXTERNAL:** Flush with plenty of water.
- **INTERNAL:** Drink large quantities of water or milk and immediately call a physician.
- **EYES:** Flush with water for 15 minutes and seek prompt medical attention.
- **Batteries produce explosive hydrogen gas. Therefore, keep sparks, flames, cigarettes, etc., away from the battery and provide sufficient ventilation when charging it in an enclosed space.**
- **KEEP THIS AND ALL BATTERIES OUT OF THE REACH OF CHILDREN.**

### To charge the battery

Have a Yamaha dealer charge the bat-

tery as soon as possible if it seems to have discharged. Keep in mind that the battery tends to discharge more quickly if the vehicle is equipped with optional electrical accessories.

ECA16520

### **NOTICE**

**To charge a VRLA (Valve Regulated Lead Acid) battery, a special (constant-voltage) battery charger is required. Using a conventional battery charger will damage the battery. If you do not have access to a constant-voltage battery charger, have a Yamaha dealer charge your battery.**

### To store the battery

1. If the model will not be used for more than one month, remove the battery, fully charge it, and then place it in a cool, dry place.  
**NOTICE:** When removing the battery, be sure the key is turned to “OFF” before disconnecting the coupler.[ECA16322]
2. If the battery will be stored for more than two months, check it at least once a month and fully

# PERIODIC MAINTENANCE AND ADJUSTMENT

charge it if necessary.

3. Fully charge the battery before installation.

ECA16530

## NOTICE

**Always keep the battery charged. Storing a discharged battery can cause permanent battery damage.**

EAU23503

## Replacing the fuse

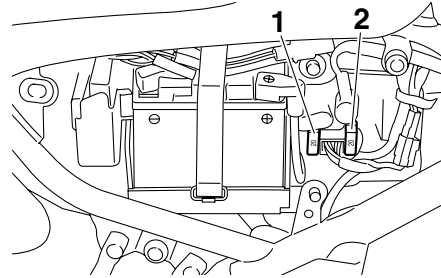

1. Fuse
2. Spare fuse

The fuse holder is located behind panel C. (See page 7-9.)

If the fuse is blown, replace it as follows.

1. Turn the key to “OFF” and turn off all electrical circuits.
2. Remove the blown fuse, and then install a new fuse of the specified amperage. **WARNING! Do not use a fuse of a higher amperage rating than recommended to avoid causing extensive damage to the electrical system and possibly a fire.**<sup>[EWA15131]</sup>

**Specified fuse:**  
20.0 A

3. Turn the key to “ON” and turn on the electrical circuits to check if the devices operate.
4. If the fuse immediately blows again, have a Yamaha dealer check the electrical system.

# PERIODIC MAINTENANCE AND ADJUSTMENT

## Replacing the headlight bulb

This model is equipped with a quartz bulb headlight. If the headlight bulb burns out, replace it as follows.

### NOTICE

Do not touch the glass part of the headlight bulb to keep it free from oil, otherwise the transparency of the glass, the luminosity of the bulb, and the bulb life will be adversely affected. Thoroughly clean off any dirt and fingerprints on the headlight bulb using a cloth moistened with alcohol or thinner.

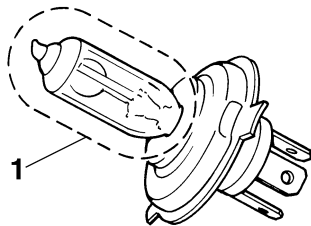

1. Do not touch the glass part of the bulb.

EAU23814

ECA10660

1. Remove cowling A. (See page 7-9.)
2. Remove the headlight unit by removing the bolts.

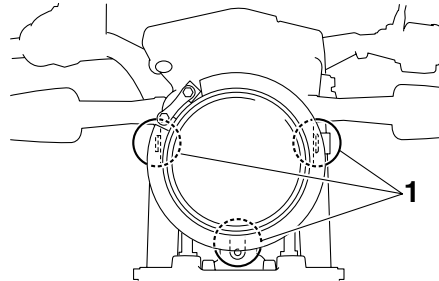

1. Bolt
3. Disconnect the headlight coupler, and then remove the headlight bulb cover.

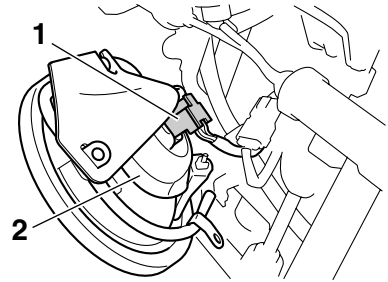

1. Headlight coupler
2. Headlight bulb cover
4. Remove the headlight bulb holder by turning it counterclockwise, and then remove the burnt-out bulb.

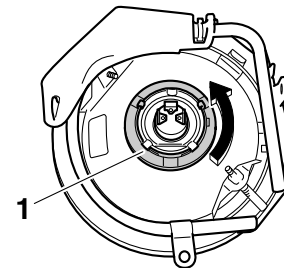

1. Headlight bulb holder
5. Place a new bulb into position, and then secure it with the bulb holder.

# PERIODIC MAINTENANCE AND ADJUSTMENT

6. Install the bulb cover, and then connect the coupler.
7. Place the headlight unit in the original position, and then install the bolts.
8. Install the cowling.
9. Have a Yamaha dealer adjust the headlight beam if necessary.

## Replacing the tail/brake light bulb

EAU24133

1. Remove the tail/brake light lens by removing the screws.

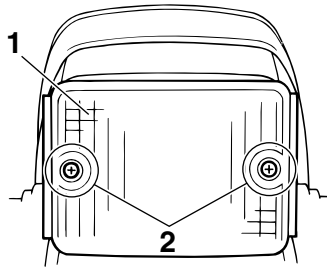

1. Tail/brake light lens
2. Screw

2. Remove the burnt-out bulb by pushing it in and turning it counter-clockwise.

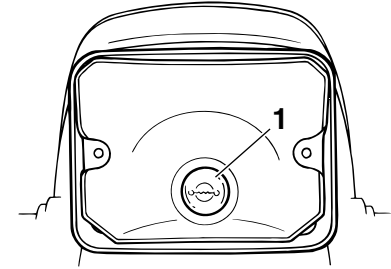

1. Tail/brake light bulb
3. Insert a new bulb into the socket, push it in, and then turn it clockwise until it stops.
4. Install the lens by installing the screws. **NOTICE: Do not over-tighten the screws, otherwise the lens may break.**<sup>[ECA10681]</sup>



EAU24204

## Replacing a turn signal light bulb

1. Remove the turn signal light lens by removing the screw.

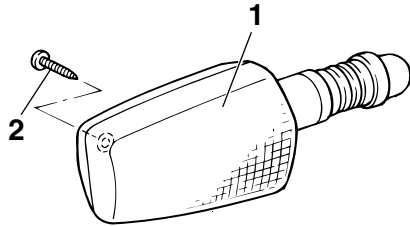

1. Turn signal light lens
2. Screw

2. Remove the burnt-out bulb by pushing it in and turning it counter-clockwise.

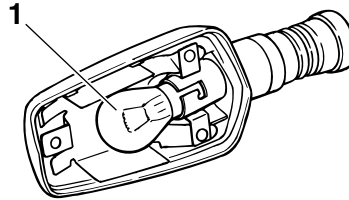

1. Turn signal light bulb
3. Insert a new bulb into the socket, push it in, and then turn it clockwise until it stops.
4. Install the lens by installing the screw. **NOTICE: Do not overtighten the screw, otherwise the lens may break.** [ECA11191]

EAU24350

## Supporting the motorcycle

Since this model is not equipped with a centerstand, follow these precautions when removing the front and rear wheel or performing other maintenance requiring the motorcycle to stand upright. Check that the motorcycle is in a stable and level position before starting any maintenance. A strong wooden box can be placed under the engine for added stability.

### To service the front wheel

1. Stabilize the rear of the motorcycle by using a motorcycle stand or, if an additional motorcycle stand is not available, by placing a jack under the frame in front of the rear wheel.
2. Raise the front wheel off the ground by using a motorcycle stand.

### To service the rear wheel

Raise the rear wheel off the ground by using a motorcycle stand or, if a motorcycle stand is not available, by placing a jack either under each side of the

# PERIODIC MAINTENANCE AND ADJUSTMENT

frame in front of the rear wheel or under each side of the swingarm.

## Front wheel

EAU24360

### To remove the front wheel

EAUW0213

EWA10821



### WARNING

To avoid injury, securely support the vehicle so there is no danger of it falling over.

1. Loosen the axle nut.

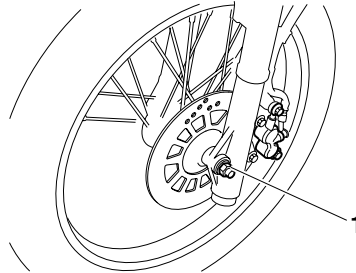

1. Axle nut
2. Lift the front wheel off the ground according to the procedure in "Supporting the motorcycle" on page 7-35.
3. Remove the axle nut, pull the wheel axle out, and then remove

the wheel. **NOTICE:** Do not apply the brake after the wheel has been removed together with the brake disc, otherwise the brake pads will be forced shut.<sup>[ECA11071]</sup>

EAUW0230

### To install the front wheel

1. Lift the wheel up between the fork legs.

### TIP

Make sure that there is enough space between the brake pads before inserting the brake disc into the caliper.

2. Insert the wheel axle, and then install the axle nut.
3. Lower the front wheel so that it is on the ground.
4. Tighten the axle nut to the specified torque.

### Tightening torque:

Axle nut:  
85 Nm (8.5 m·kgf, 61.5 ft·lbf)

5. Push down hard on the handlebar several times to check for proper fork operation.

# PERIODIC MAINTENANCE AND ADJUSTMENT

## Rear wheel

EAU25080

### To remove the rear wheel

EAU37853

EWA10821



**WARNING**

To avoid injury, securely support the vehicle so there is no danger of it falling over.

1. Loosen the axle nut.
2. Lift the rear wheel off the ground according to the procedure on page 7-35.
3. Turn the drive chain adjusting plate on each side of the swingarm fully in direction (a).
4. Push the wheel forward, and then remove the drive chain from the rear sprocket.

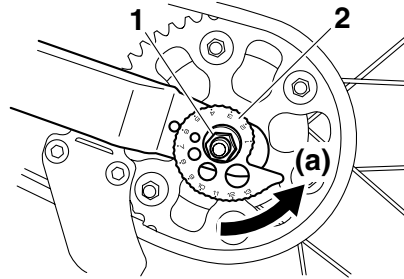

1. Axle nut
2. Drive chain adjusting plate

### TIP

The drive chain does not need to be disassembled in order to remove and install the wheel.

5. Remove the axle nut and the drive chain adjusting plate from the left-hand side.
6. While supporting the brake caliper, pull the wheel axle out together with the drive chain adjusting plate from the right-hand side.

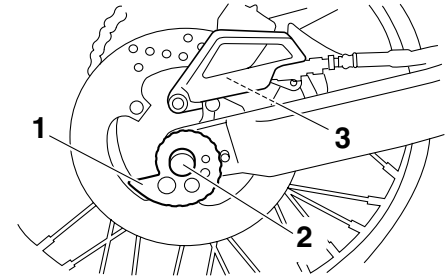

1. Drive chain adjusting plate
2. Wheel axle
3. Brake caliper

7. Remove the wheel by pulling it to the back. **NOTICE: Do not apply the brake after the wheel has been removed together with the brake disc, otherwise the brake pads will be forced shut.**<sup>[ECA11071]</sup>

EAU37860

### To install the rear wheel

1. Install the drive chain adjusting plates, the wheel and the brake caliper bracket by inserting the wheel axle from the right-hand side.

# PERIODIC MAINTENANCE AND ADJUSTMENT

## TIP

- Make sure that the drive chain adjusting plates are installed with the punched sides facing to the outside and that the retainer on the swingarm is inserted into the slot in the brake caliper bracket.
- Make sure that there is enough space between the brake pads before installing the wheel.

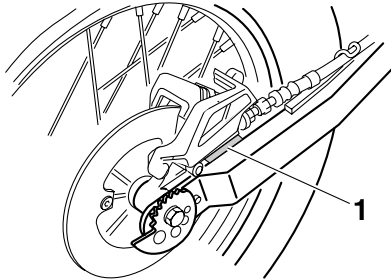

1. Retainer
2. Install the drive chain onto the rear sprocket, and then adjust the drive chain slack. (See page 7-25.)
3. Install the axle nut, and then lower the rear wheel so that it is on the ground.

4. Tighten the axle nut to the specified torque.

### Tightening torque:

Axle nut:  
85 Nm (8.5 m·kgf, 61.5 ft·lbf)

EAU25851

## Troubleshooting

Although Yamaha motorcycles receive a thorough inspection before shipment from the factory, trouble may occur during operation. Any problem in the fuel, compression, or ignition systems, for example, can cause poor starting and loss of power.

The following troubleshooting chart represents a quick and easy procedure for checking these vital systems yourself. However, should your motorcycle require any repair, take it to a Yamaha dealer, whose skilled technicians have the necessary tools, experience, and know-how to service the motorcycle properly.

Use only genuine Yamaha replacement parts. Imitation parts may look like Yamaha parts, but they are often inferior, have a shorter service life and can lead to expensive repair bills.

EWA15141

### **WARNING**

**When checking the fuel system, do not smoke, and make sure there are no open flames or sparks in the area, including pilot lights from water**

## **PERIODIC MAINTENANCE AND ADJUSTMENT**

---

heaters or furnaces. Gasoline or gasoline vapors can ignite or explode, causing severe injury or property damage.

---

# PERIODIC MAINTENANCE AND ADJUSTMENT

EAU25902

## Troubleshooting chart

### 1. Fuel

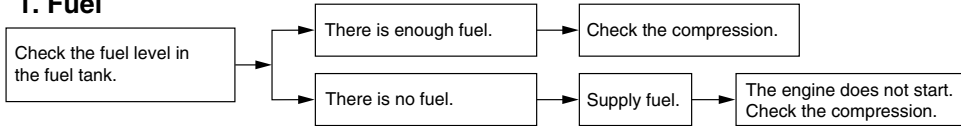

### 2. Compression

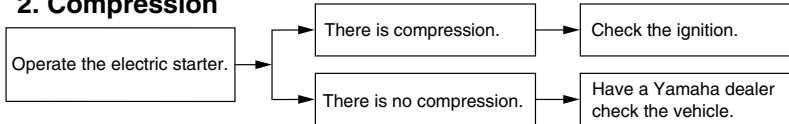

### 3. Ignition

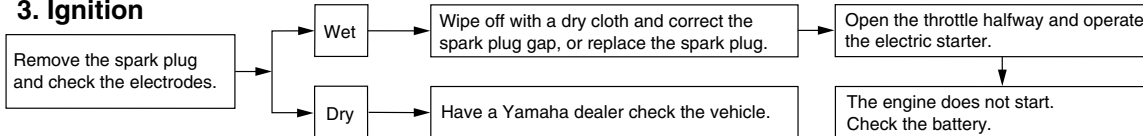

### 4. Battery

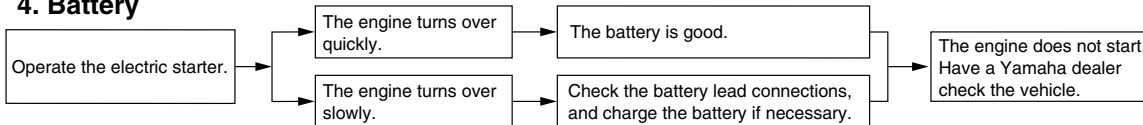

## Matte color caution

EAU37833

EAU26004

### NOTICE

Some models are equipped with matte colored finished parts. Be sure to consult a Yamaha dealer for advice on what products to use before cleaning the vehicle. Using a brush, harsh chemical products or cleaning compounds when cleaning these parts will scratch or damage their surface. Wax also should not be applied to any matte colored finished parts.

ECA15192

## Care

While the open design of a motorcycle reveals the attractiveness of the technology, it also makes it more vulnerable. Rust and corrosion can develop even if high-quality components are used. A rusty exhaust pipe may go unnoticed on a car, however, it detracts from the overall appearance of a motorcycle. Frequent and proper care does not only comply with the terms of the warranty, but it will also keep your motorcycle looking good, extend its life and optimize its performance.

### Before cleaning

1. Cover the muffler outlet with a plastic bag after the engine has cooled down.
2. Make sure that all caps and covers as well as all electrical couplers and connectors, including the spark plug cap, are tightly installed.
3. Remove extremely stubborn dirt, like oil burnt onto the crankcase, with a degreasing agent and a brush, but never apply such prod-

ucts onto seals, gaskets, sprockets, the drive chain and wheel axles. Always rinse the dirt and degreaser off with water.

## Cleaning

ECA10772

### NOTICE

- Avoid using strong acidic wheel cleaners, especially on spoked wheels. If such products are used on hard-to-remove dirt, do not leave the cleaner on the affected area any longer than instructed. Also, thoroughly rinse the area off with water, immediately dry it, and then apply a corrosion protection spray.
- Improper cleaning can damage plastic parts (such as cowlings, panels, windshields, headlight lenses, meter lenses, etc.) and the mufflers. Use only a soft, clean cloth or sponge with water to clean plastic. However, if the plastic parts cannot be thoroughly cleaned with water, diluted mild detergent with water may be used. Be sure to rinse

# MOTORCYCLE CARE AND STORAGE

---

off any detergent residue using plenty of water, as it is harmful to plastic parts.

- Do not use any harsh chemical products on plastic parts. Be sure to avoid using cloths or sponges which have been in contact with strong or abrasive cleaning products, solvent or thinner, fuel (gasoline), rust removers or inhibitors, brake fluid, antifreeze or electrolyte.
- Do not use high-pressure washers or steam-jet cleaners since they cause water seepage and deterioration in the following areas: seals (of wheel and swing-arm bearings, fork and brakes), electric components (couplers, connectors, instruments, switches and lights), breather hoses and vents.
- For motorcycles equipped with a windshield: Do not use strong cleaners or hard sponges as they will cause dulling or scratching. Some cleaning compounds for plastic may leave

scratches on the windshield. Test the product on a small hidden part of the windshield to make sure that it does not leave any marks. If the windshield is scratched, use a quality plastic polishing compound after washing.

---

## After normal use

Remove dirt with warm water, a mild detergent, and a soft, clean sponge, and then rinse thoroughly with clean water. Use a toothbrush or bottlebrush for hard-to-reach areas. Stubborn dirt and insects will come off more easily if the area is covered with a wet cloth for a few minutes before cleaning.

## After riding in the rain, near the sea or on salt-sprayed roads

Since sea salt or salt sprayed on roads during winter are extremely corrosive in combination with water, carry out the following steps after each ride in the rain, near the sea or on salt-sprayed roads.

## TIP

Salt sprayed on roads in the winter may remain well into spring.

---

1. Clean the motorcycle with cold water and a mild detergent, after the engine has cooled down.  
**NOTICE: Do not use warm water since it increases the corrosive action of the salt.**[ECA10791]
2. Apply a corrosion protection spray on all metal, including chrome- and nickel-plated, surfaces to prevent corrosion.

## After cleaning

1. Dry the motorcycle with a chamois or an absorbing cloth.
2. Immediately dry the drive chain and lubricate it to prevent it from rusting.
3. Use a chrome polish to shine chrome, aluminum and stainless-steel parts, including the exhaust system. (Even the thermally induced discoloring of stainless-steel exhaust systems can be removed through polishing.)



# MOTORCYCLE CARE AND STORAGE

4. To prevent corrosion, it is recommended to apply a corrosion protection spray on all metal, including chrome- and nickel-plated, surfaces.
5. Use spray oil as a universal cleaner to remove any remaining dirt.
6. Touch up minor paint damage caused by stones, etc.
7. Wax all painted surfaces.
8. Let the motorcycle dry completely before storing or covering it.

EWA11131

## WARNING

**Contaminants on the brakes or tires can cause loss of control.**

- **Make sure that there is no oil or wax on the brakes or tires.**
- **If necessary, clean the brake discs and brake linings with a regular brake disc cleaner or acetone, and wash the tires with warm water and a mild detergent. Before riding at higher speeds, test the motorcycle's braking performance and cornering behavior.**

ECA10800

## NOTICE

- **Apply spray oil and wax sparingly and make sure to wipe off any excess.**
- **Never apply oil or wax to any rubber and plastic parts, but treat them with a suitable care product.**
- **Avoid using abrasive polishing compounds as they will wear away the paint.**

## TIP

- Consult a Yamaha dealer for advice on what products to use.
- Washing, rainy weather or humid climates can cause the headlight lens to fog. Turning the headlight on for a short period of time will help remove the moisture from the lens.

EAU26151

## Storage

### Short-term

Always store your motorcycle in a cool, dry place and, if necessary, protect it against dust with a porous cover.

ECA10810

## NOTICE

- **Storing the motorcycle in a poorly ventilated room or covering it with a tarp, while it is still wet, will allow water and humidity to seep in and cause rust.**
- **To prevent corrosion, avoid damp cellars, stables (because of the presence of ammonia) and areas where strong chemicals are stored.**

### Long-term

Before storing your motorcycle for several months:

1. Follow all the instructions in the "Care" section of this chapter.
2. For motorcycles equipped with a fuel cock that has an "OFF" position: Turn the fuel cock lever to "OFF".

# MOTORCYCLE CARE AND STORAGE

---

3. Drain the carburetor float chamber by loosening the drain bolt; this will prevent fuel deposits from building up. Pour the drained fuel into the fuel tank.
4. Fill up the fuel tank and add fuel stabilizer (if available) to prevent the fuel tank from rusting and the fuel from deteriorating.
5. Perform the following steps to protect the cylinder, piston rings, etc. from corrosion.
  - a. Remove the spark plug cap and spark plug.
  - b. Pour a teaspoonful of engine oil into the spark plug bore.
  - c. Install the spark plug cap onto the spark plug, and then place the spark plug on the cylinder head so that the electrodes are grounded. (This will limit sparking during the next step.)
  - d. Turn the engine over several times with the starter. (This will coat the cylinder wall with oil.)**WARNING! To prevent damage or injury from sparking, make sure to ground the**

**spark plug electrodes while turning the engine over.**<sup>[EWA10951]</sup>

- e. Remove the spark plug cap from the spark plug, and then install the spark plug and the spark plug cap.
6. Lubricate all control cables and the pivoting points of all levers and pedals as well as of the sidestand/centerstand.
7. Check and, if necessary, correct the tire air pressure, and then lift the motorcycle so that both of its wheels are off the ground. Alternatively, turn the wheels a little every month in order to prevent the tires from becoming degraded in one spot.
8. Cover the muffler outlet with a plastic bag to prevent moisture from entering it.
9. Remove the battery and fully charge it. Store it in a cool, dry place and charge it once a month. Do not store the battery in an excessively cold or warm place [less than 0 °C (30 °F) or more than 30

°C (90 °F)]. For more information on storing the battery, see page 7-31.

---

## TIP

Make any necessary repairs before storing the motorcycle.

---

## Dimensions:

- Overall length:  
2150 mm (84.6 in)
- Overall width:  
805 mm (31.7 in)
- Overall height:  
1160 mm (45.7 in)
- Seat height:  
810 mm (31.9 in)
- Wheelbase:  
1360 mm (53.5 in)
- Ground clearance:  
285 mm (11.22 in)
- Minimum turning radius:  
1900 mm (74.8 in)

## Weight:

- With oil and fuel:  
132.0 kg (291 lb)

## Engine:

- Engine type:  
Air cooled 4-stroke, SOHC
- Cylinder arrangement:  
Forward-inclined single cylinder
- Displacement:  
249 cm<sup>3</sup>
- Bore × stroke:  
74.0 × 58.0 mm (2.91 × 2.28 in)
- Compression ratio:  
9.50 :1
- Starting system:  
Electric starter
- Lubrication system:  
Wet sump

## Engine oil:

- Recommended brand:  
YAMALUBE
- Type:  
SAE 10W-30, 10W-40, 10W-50, 15W-40,  
20W-40 or 20W-50

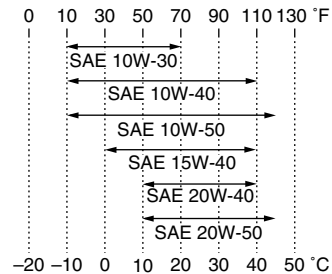

- Recommended engine oil grade:  
API service SG type or higher, JASO standard MA

## Engine oil quantity:

- Without oil filter element replacement:  
1.20 L (1.27 US qt, 1.06 Imp.qt)
- With oil filter element replacement:  
1.30 L (1.37 US qt, 1.14 Imp.qt)

## Air filter:

- Air filter element:  
Oil-coated paper element

## Fuel:

- Recommended fuel:  
Regular unleaded gasoline only

## Fuel tank capacity:

- 9.1 L (2.40 US gal, 2.00 Imp.gal) (CAL)
- 9.8 L (2.59 US gal, 2.16 Imp.gal) (U49)

## Fuel reserve amount:

- 1.9 L (0.50 US gal, 0.42 Imp.gal)

## Carburetor:

- Type × quantity:  
MV33 x 1

## Spark plug (s):

- Manufacturer/model:  
NGK/DR7EA
- Spark plug gap:  
0.6–0.7 mm (0.024–0.028 in)

## Clutch:

- Clutch type:  
Wet, multiple-disc

## Transmission:

- Primary reduction system:  
Spur gear
- Primary reduction ratio:  
74/24 (3.083)
- Secondary reduction system:  
Chain drive
- Secondary reduction ratio:  
48/15 (3.200)
- Transmission type:  
Constant mesh 5-speed
- Operation:  
Left foot operation

## Gear ratio:

- 1st:  
37/13 (2.846)
- 2nd:  
29/16 (1.812)

# SPECIFICATIONS

3rd:  
29/22 (1.318)

4th:  
29/28 (1.035)

5th:  
23/28 (0.821)

## Chassis:

Frame type:  
Semi double cradle

Caster angle:  
26.42 °

Trail:  
106.0 mm (4.17 in)

## Front tire:

Type:  
With tube

Size:  
2.75-21 45P

Manufacturer/model:  
BRIDGESTONE/TW-301

## Rear tire:

Type:  
With tube

Size:  
120/80-18M/C 62P

Manufacturer/model:  
BRIDGESTONE/TW-302F

## Loading:

Maximum load:  
160 kg (353 lb)

\* (Total weight of rider, passenger, cargo and accessories)

## Tire air pressure (measured on cold tires):

Loading condition:  
0–90 kg (0–198 lb)

Front:  
125 kPa (1.25 kgf/cm<sup>2</sup>, 18 psi)

Rear:  
150 kPa (1.50 kgf/cm<sup>2</sup>, 22 psi)

Loading condition:  
90–160 kg (198–353 lb)

Front:  
150 kPa (1.50 kgf/cm<sup>2</sup>, 22 psi)

Rear:  
175 kPa (1.75 kgf/cm<sup>2</sup>, 25 psi)

## Front wheel:

Wheel type:  
Spoke wheel

Rim size:  
21x1.60

## Rear wheel:

Wheel type:  
Spoke wheel

Rim size:  
18M/C x MT2.15

## Front brake:

Type:  
Single disc brake

Operation:  
Right hand operation

Recommended fluid:  
DOT 4

## Rear brake:

Type:  
Single disc brake

Operation:  
Right foot operation

Recommended fluid:  
DOT 4

## Front suspension:

Type:  
Telescopic fork

Spring/shock absorber type:  
Coil spring/oil damper

Wheel travel:  
225.0 mm (8.86 in)

## Rear suspension:

Type:  
Swingarm (link suspension)

Spring/shock absorber type:  
Coil spring/gas-oil damper

Wheel travel:  
180.0 mm (7.09 in)

## Electrical system:

Ignition system:  
CDI

Charging system:  
AC magneto

## Battery:

Model:  
YTZ7S

Voltage, capacity:  
12 V, 6.0 Ah

## Headlight:

Bulb type:  
Halogen bulb

**Bulb voltage, wattage × quantity:**

Headlight:

12 V, 60 W/55 W × 1

Tail/brake light:

12 V, 8.0 W/27.0 W × 1

Front turn signal/position light:

12 V, 27 W/8.0 W × 2

Rear turn signal light:

12 V, 27.0 W × 2

Neutral indicator light:

LED

High beam indicator light:

LED

Turn signal indicator light:

LED

**Fuse:**

Main fuse:

20.0 A

# CONSUMER INFORMATION

EAU26352

## Identification numbers

Record the key identification number, vehicle identification number and model label information in the spaces provided below for assistance when ordering spare parts from a Yamaha dealer or for reference in case the vehicle is stolen.

KEY IDENTIFICATION NUMBER:

VEHICLE IDENTIFICATION NUMBER:

MODEL LABEL INFORMATION:

## Key identification number

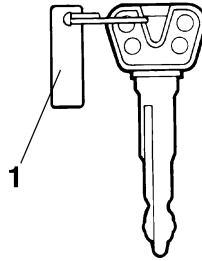

1. Key identification number

The key identification number is stamped into the key tag. Record this number in the space provided and use it for reference when ordering a new key.

EAU26381

## Vehicle identification number

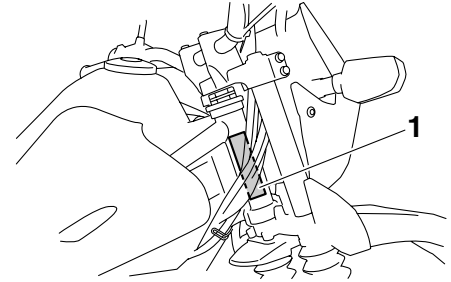

1. Vehicle identification number

The vehicle identification number is stamped into the steering head pipe. Record this number in the space provided.

### TIP

The vehicle identification number is used to identify your motorcycle and may be used to register your motorcycle with the licensing authority in your area.

EAU26400

## Model label

EAU36980

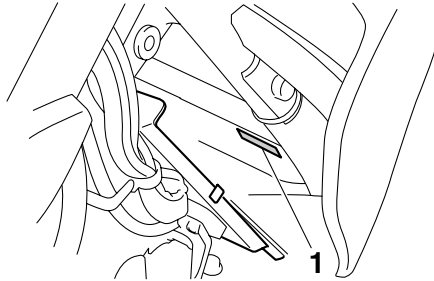

### 1. Model label

The model label is affixed to the frame behind panel A. (See page 7-9.) Record the information on this label in the space provided. This information will be needed when ordering spare parts from a Yamaha dealer.

## Vehicle Emission Control Information label

EAU48060

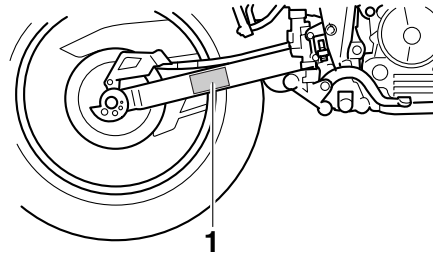

### 1. Vehicle Emission Control Information label

The Vehicle Emission Control Information label is affixed at the location in the illustration. This label shows specifications related to exhaust emissions as required by federal law, state law and Environment Canada.

# CONSUMER INFORMATION

---

EAU26551

## Reporting safety defects

If you believe that your vehicle has a defect which could cause a crash or could cause injury or death, you should immediately inform the National Highway Traffic Safety Administration (NHTSA) in addition to notifying Yamaha Motor Corporation, U.S.A. If NHTSA receives similar complaints, it may open an investigation, and if it finds that a safety defect exists in a group of vehicles, it may order a recall and remedy campaign. However, NHTSA cannot become involved in individual problems between you, your dealer, or Yamaha Motor Corporation, U.S.A.

To contact NHTSA, you may call the Vehicle Safety Hotline toll-free at 1-888-327-4236 (TTY: 1-800-424-9153); go to <http://www.safercar.gov>; or write to: Administrator, NHTSA, 400 Seventh Street, SW., Washington, DC 20590. You can also obtain other information about motor vehicle safety from <http://www.safercar.gov>.



## Motorcycle noise regulation

### TAMPERING WITH NOISE CONTROL SYSTEM PROHIBITED:

Federal law prohibits the following acts or the causing thereof: (1) The removal or rendering inoperative by any person other than for purposes of maintenance, repair, or replacement of any device or element of design incorporated into any new vehicle for the purpose of noise control prior to its sale or delivery to the ultimate purchaser or while it is in use or (2) the use of the vehicle after such device or element of design has been removed or rendered inoperative by any person.

“AMONG THOSE ACTS PRESUMED TO CONSTITUTE TAMPERING ARE THE ACTS LISTED BELOW”.

These acts include tampering with the following systems; i.e., modification, removal, etc.

#### **Exhaust system**

- Muffler
- Exhaust pipe
- Silencer

#### **Intake system**

- Air cleaner case
- Air cleaner element
- Intake duct

# CONSUMER INFORMATION

EAU26611

## Maintenance record

Copies of work orders and/or receipts for parts purchased and installed on your motorcycle will be required to document that maintenance has been completed in accordance with the emissions warranty. The chart below is printed only as a reminder that maintenance work is required. It is not acceptable proof of maintenance work.

Maintenance interval	Date of service	Mileage	Servicing dealer name and address	Remarks
600 mi (1000 km) or 1 month				
4000 mi (6000 km) or 6 months				
7000 mi (11000 km) or 12 months				
10000 mi (16000 km) or 18 months				
13000 mi (21000 km) or 24 months				
16000 mi (26000 km) or 30 months				
19000 mi (31000 km) or 36 months				
22000 mi (36000 km) or 42 months				
25000 mi (41000 km) or 48 months				

# CONSUMER INFORMATION

<b>Maintenance interval</b>	<b>Date of service</b>	<b>Mileage</b>	<b>Servicing dealer name and address</b>	<b>Remarks</b>
28000 mi (46000 km) or 54 months				
31000 mi (51000 km) or 60 months				

# CONSUMER INFORMATION

EAU26663

## YAMAHA MOTOR CORPORATION, U.S.A. STREET AND ENDURO MOTORCYCLE LIMITED WARRANTY

Yamaha Motor Corporation, U.S.A. hereby warrants that new Yamaha motorcycles will be free from defects in material and workmanship for the period of time stated herein, subject to certain stated limitations.

**THE PERIOD OF WARRANTY** for Yamaha motorcycles originally equipped with headlight, stoplight, and turn signals shall be one (1) year from the date of purchase, with no mileage limitation.

**MODELS EXCLUDED FROM WARRANTY** include those used for non-Yamaha-authorized renting, leasing or other commercial purposes, and TZ models.

**DURING THE PERIOD OF WARRANTY**, any authorized Yamaha motorcycle dealer will, free of charge, repair or replace any part adjudged defective by Yamaha due to faulty workmanship or material from the factory. Parts used in warranty repairs will be warranted for the balance of the product's warranty period. All parts replaced under warranty become property of Yamaha Motor Corporation, U.S.A.

**GENERAL EXCLUSIONS** from this warranty shall include any failures caused by:

- Competition or racing use.
- Installation of parts or accessories that are not qualitatively equivalent to genuine Yamaha parts.
- Abnormal strain, neglect, or abuse.
- Lack of proper maintenance.
- Accident or collision damage.
- Modification to original parts.

**SPECIFIC EXCLUSIONS** from this warranty shall include parts replaced due to normal wear or routine maintenance.

**THE CUSTOMER'S RESPONSIBILITY** under this warranty shall be to:

- Operate and maintain the motorcycle as specified in the appropriate Owner's Manual, and
- Give notice to an authorized Yamaha motorcycle dealer of any and all apparent defects within ten (10) days after discovery, and make the machine available at that time for inspection and repairs at such dealer's place of business.

**WARRANTY TRANSFER:** To transfer the warranty from the original purchaser to any subsequent purchaser, it is imperative that the machine be inspected and registered for warranty by an authorized Yamaha motorcycle dealer. In order for this warranty to remain in effect, this inspection and registration must take place within ten (10) days after transfer. An inspection and registration fee will be charged for this service.

### EMISSION CONTROL SYSTEM WARRANTY:

Yamaha Motor Corporation, U.S.A. also warrants to the ultimate purchaser and each subsequent purchaser of each Yamaha motorcycle covered by this warranty with a displacement of 50cc or greater, that the vehicle is designed, built, and equipped so as to conform at the time of sale with all U.S. emissions standards applicable at the time of manufacture and that it is free from defects in materials and workmanship which would cause it not to meet these standards within the period listed immediately below. Failures other than those resulting from defects in material or workmanship, which arise solely as a result of owner abuse and/or lack of proper maintenance, are not covered by this warranty.

Engine Displacement	Period
Under 50cc	6,000 km (3,750 miles) or five years, whichever occurs first
50cc to 169cc	12,000 km (7,465 miles) or five years whichever occurs first
170cc to 279cc	18,000 km (11,185 miles) or five years, whichever occurs first
280cc and over	30,000 km (18,641 miles) or five years, whichever occurs first

**YAMAHA MOTOR CORPORATION, U.S.A. MAKES NO OTHER WARRANTY OF ANY KIND, EXPRESSED OR IMPLIED. ALL IMPLIED WARRANTIES OF MERCHANTABILITY AND FITNESS FOR A PARTICULAR PURPOSE WHICH EXCEED THE OBLIGATIONS AND TIME LIMITS STATED IN THIS WARRANTY ARE HEREBY DISCLAIMED BY YAMAHA MOTOR CORPORATION, U.S.A. AND EXCLUDED FROM THIS WARRANTY.**

**SOME STATES DO NOT ALLOW LIMITATIONS ON HOW LONG AN IMPLIED WARRANTY LASTS, SO THE ABOVE LIMITATION MAY NOT APPLY TO YOU. ALSO EXCLUDED FROM THIS WARRANTY ARE ANY INCIDENTAL OR CONSEQUENTIAL DAMAGES INCLUDING LOSS OF USE. SOME STATES DO NOT ALLOW THE EXCLUSION OR LIMITATION OF INCIDENTAL OR CONSEQUENTIAL DAMAGES, SO THE ABOVE EXCLUSION MAY NOT APPLY TO YOU.**

**THIS WARRANTY GIVES YOU SPECIFIC LEGAL RIGHTS, AND YOU MAY ALSO HAVE OTHER RIGHTS WHICH VARY FROM STATE TO STATE.**

YAMAHA MOTOR CORPORATION, U.S.A.  
P.O. Box 6555  
Cypress, California 90630

## WARRANTY QUESTIONS AND ANSWERS

- Q. What costs are my responsibility during the warranty period?
- A. The customer's responsibility includes all costs of normal maintenance services, non-warranty repairs, accident and collision damages, and oil, oil filters, air filters, spark plugs, and brake shoes.
- Q. What are some examples of "abnormal" strain, neglect, or abuse?
- A. These terms are general and overlap each other in areas. Specific examples include: Running the machine out of oil, sustained high rpm, full-throttle, operating the machine with a broken or damaged part which causes another part to fail, damage or failure due to improper or careless transportation and/or tie-down. If you have any specific questions on operation or maintenance, please contact your dealer for advice.
- Q. Does the warranty cover incidental costs such as towing or transportation due to a failure?
- A. No. The warranty is limited to repair of the machine itself.
- Q. May I perform any or all of the recommended maintenance shown in the Owner's Manual instead of having the dealer do them?
- A. Yes, if you are a qualified mechanic and follow the procedures specified in the Owner's and Service Manual. We do recommend, however, that items requiring special tools or equipment be done by a Yamaha motorcycle dealer.
- Q. Will the warranty be void or cancelled if I do not operate or maintain my new motorcycle exactly as specified in the Owner's Manual?
- A. No. The warranty on a new motorcycle cannot be "voided" or "cancelled." **However, if a particular failure is caused by operation or maintenance other than as described in the Owner's Manual, that failure may not be covered under warranty.**
- Q. What responsibility does my dealer have under this warranty?
- A. Each Yamaha motorcycle dealer is expected to:
1. Completely set up every new machine before sale.
  2. Explain the operation, maintenance, and warranty requirements to your satisfaction at the time of sale, and upon your request at any later date.
  3. Each Yamaha motorcycle dealer is held responsible for his setup, service and warranty repair work.
- Q. Is the warranty transferable to second owners?
- A. Yes. The remainder of the existing warranty can be transferred upon request. The unit has to be inspected and re-registered by an authorized Yamaha motorcycle dealer for the policy to remain effective.

## CUSTOMER SERVICE

If your machine requires warranty service, you must take it to any authorized Yamaha motorcycle dealer within the continental United States. Be sure to bring your warranty registration card or other valid proof of the original date of purchase. If a question or problem arises regarding the warranty, first contact the owner of the dealership. Since all warranty matters are handled at the dealer level, this person is in the best position to help you. If you are still not satisfied and require additional assistance, please write to:

YAMAHA MOTOR CORPORATION, U.S.A.  
CUSTOMER RELATIONS DEPARTMENT  
P.O. Box 6555  
Cypress, California 90630

When contacting Yamaha Motor Corporation, U.S.A., don't forget to include any important information such as names, addresses, model, V.I.N. (frame number), dates, and receipts.

## CHANGE OF ADDRESS

The federal government requires each manufacturer of a motor vehicle to maintain a complete, up-to-date list of all first purchasers against the possibility of a safety-related defect and recall. This list is compiled from the purchase registrations sent to Yamaha Motor Corporation, U.S.A. by the selling dealer at the time of your purchase.

If you should move after you have purchased your new motorcycle, please advise us of your new address by sending a postcard listing your motorcycle model name, V.I.N. (frame number), dealer number (or dealer's name) as it is shown on your warranty card, your name and new mailing address. Mail to:

YAMAHA MOTOR CORPORATION, U.S.A.  
P.O. Box 6555  
Cypress, California 90630  
Attention: Warranty Department

This will ensure that Yamaha Motor Corporation, U.S.A. has an up-to-date registration record in accordance with federal law.

## YAMAHA EXTENDED SERVICE (Y.E.S.)

Keep your Yamaha protected even after your warranty expires with genuine Yamaha Extended Service (Y.E.S.).

- Y.E.S. is designed and administered by Yamaha Motor Corporation to provide maximum owner satisfaction. You get uninterrupted factory-backed coverage for extra peace of mind.
  - Y.E.S. is flexible. You choose the plan that's right for you: 12 months, 24 months, 36 months or, on certain models, even 48 months beyond your warranty period.
  - Y.E.S. is designed and administered by the same Yamaha people who handle your warranty – and it shows in the comprehensive coverage benefits. There are no mileage limitations. Coverage isn't limited to “moving parts” or the “drive train” like many other plans. And Y.E.S. covers manufacturing defects just like the warranty. See the sample contract at your Yamaha dealer to see how comforting uninterrupted factory-backed protection can be.
  - You don't have to pay anything for covered repairs. There's no deductible to pay, and repairs aren't “pro-rated.” You don't have any “out-of-pocket” expenses for covered repairs.
- In addition, Travel and Recreation Interruption Protection (TRIP) is included at no extra cost. TRIP gives you up to \$150 reimbursement per occurrence for any reasonable expenses you incur because your Yamaha needs covered service: replacement vehicle rental, emergency towing, phone calls, even food and lodging when you are away from home. This superb coverage goes into effect when you purchase Y.E.S., so it applies to any warranty repairs as well as covered repairs during your entire Y.E.S. plan period.
  - Y.E.S. coverage is honored at any authorized Yamaha dealer nationwide.
  - Y.E.S. coverage is transferable to a new owner if you sell or trade-in. That can make your Yamaha much more valuable!

This excellent Y.E.S. plan coverage is only available to Yamaha owners like you, and only while your Yamaha is still within the Yamaha Limited Warranty period. So visit your authorized Yamaha dealer to get all the facts. He can show you how easy it is to protect your investment with Yamaha Extended Service.

# CONSUMER INFORMATION

We urge you to act now. You'll get the excellent benefits of TRIP coverage right away, and you'll rest easy knowing you'll have strong factory-backed protection even after your Yamaha Limited Warranty expires.

A special note:

If visiting your dealer isn't convenient, contact Yamaha with your Primary ID number (your frame number). We'll be happy to help you get the Y.E.S. coverage you need.

Yamaha Service Marketing  
P.O. Box 6555  
Cypress, CA 90630  
1-(866)-YES-EXTD (1-866-937-3983)

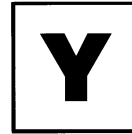

**YAMAHA**



**EXTENDED**



**SERVICE**

# INDEX

---

## A

Air filter element and check hose,  
replacing and cleaning..... 7-16

## B

Battery..... 7-31  
Brake and clutch levers, checking and  
lubricating ..... 7-28  
Brake and shift pedals, checking and  
lubricating ..... 7-27  
Brake fluid, changing ..... 7-25  
Brake fluid level, checking ..... 7-24  
Brake lever ..... 4-6  
Brake lever free play, adjusting..... 7-22  
Brake pedal..... 4-6

## C

Cables, checking and lubricating ..... 7-27  
Canister (for California only) ..... 7-13  
Carburetor..... 7-18  
Care ..... 8-1  
Clutch lever ..... 4-5  
Clutch lever free play, adjusting..... 7-21  
Cowling and panels, removing and  
installing..... 7-9

## D

Dimmer switch ..... 4-4  
Drive chain, cleaning and lubricating ..... 7-26  
Drive chain slack..... 7-25

## E

Engine break-in..... 6-4  
Engine idling speed, checking ..... 7-18  
Engine oil and oil filter element..... 7-13  
Engine, starting a warm ..... 6-2  
Engine stop switch..... 4-5

## F

Front and rear brake pads, checking..... 7-23  
Front fork, checking..... 7-29  
Fuel..... 4-7  
Fuel cock ..... 4-8  
Fuel tank cap ..... 4-6  
Fuse, replacing..... 7-32

## H

Handlebar switches ..... 4-4  
Headlight bulb, replacing..... 7-33  
Helmet holder ..... 4-10  
High beam indicator light..... 4-2  
Horn switch..... 4-5

## I

Identification numbers ..... 10-1  
Ignition circuit cut-off system ..... 4-13  
Indicator lights ..... 4-2

## K

Key identification number ..... 10-1

## L

Labels, location..... 1-1

## M

Main switch/steering lock..... 4-1  
Maintenance and lubrication, periodic ..... 7-5  
Maintenance, emission control system..... 7-3  
Maintenance record..... 10-5  
Matte color, caution ..... 8-1  
Model label ..... 10-2  
Multi-function display ..... 4-3

## N

Neutral indicator light..... 4-2  
Noise regulation..... 10-4

## P

Parking..... 6-4  
Part locations ..... 3-1

## R

Rear brake light switch, adjusting ..... 7-23  
Rear suspension, lubricating..... 7-29

## S

Safety defects, reporting ..... 10-3  
Safety information ..... 2-1  
Seat ..... 4-10  
Shifting ..... 6-2  
Shift pedal ..... 4-5  
Shock absorber assembly, adjusting ..... 4-11  
Sidestand ..... 4-12  
Sidestand, checking and lubricating..... 7-29  
Spark arrester, cleaning ..... 7-17  
Spark plug, checking..... 7-11  
Specifications ..... 9-1  
Starter (choke) knob..... 4-9  
Starting and warming up a cold engine..... 6-1  
Start switch..... 4-5  
Steering, checking..... 7-30  
Storage..... 8-3  
Supporting the motorcycle ..... 7-35

## T

Tail/brake light bulb, replacing ..... 7-34  
Throttle cable free play, checking ..... 7-18  
Throttle grip and cable, checking and  
lubricating..... 7-27  
Tires ..... 7-19  
Tool kit..... 7-2  
Troubleshooting ..... 7-38  
Troubleshooting chart ..... 7-40  
Turn signal indicator light ..... 4-2



Turn signal light bulb, replacing ..... 7-35  
Turn signal switch ..... 4-4

## **V**

Valve clearance ..... 7-19  
Vehicle Emission Control Information  
  label ..... 10-2  
Vehicle identification number ..... 10-1

## **W**

Warranty, extended ..... 10-10  
Warranty, limited ..... 10-8  
Wheel bearings, checking ..... 7-30  
Wheel (front) ..... 7-36  
Wheel (rear) ..... 7-37  
Wheels ..... 7-21





***PROTECT YOUR INVESTMENT  
Use Genuine YAMAHA Parts And Accessories.***

***See your Authorized YAMAHA Dealer for a Genuine YAMAHA  
Service Manual.***



YAMAHA MOTOR CO., LTD.

PRINTED ON RECYCLED PAPER

PRINTED IN JAPAN

2009.05-0.8x1 

(E)