



## **X-TRAINER 300 2T**

Thanks for your preference, and have a good time! This handbook contains the information you need to properly operate and maintain your motorcycle.

The data, specifications and images shown in this manual does not constitute an engagement on the part of BETAMOTOR S.p.A. BETAMOTOR reserves the right to make any changes and improvements to its models at any moment and without notice.

Code 036440040 000

## IMPORTANT

We recommend you to check all the tightenings after the first one or two hours' ride over rough ground. Special attention should be paid to the following parts:

- rear sprocket
- ensure that the footrests are properly fixed
- front/rear brake levers/calipers/discs
- check that the plastics are properly fastened
- engine bolts
- shock absorber bolts/swingarm
- wheel hubs/spokes
- rear frame
- pipe connections
- tensioning the chain

## IMPORTANT

In the event of interventions on the vehicle, contact Betamotor after-sales service.

CONTENTS	
Operating instructions.....	5
Symbols.....	5
Riding safety .....	6
<b>CHAPTER 1 GENERAL INFORMATION .....</b>	<b>7</b>
Vehicle identification data .....	8
Tools kit .....	8
Familiarizing with the vehicle.....	9
Specifications .....	10
Electrical system.....	14
Recommended lubricants and liquid .....	16
<b>CHAPTER 2 OPERATION .....</b>	<b>17</b>
Main parts .....	18
Digital rpm indicator operating instructions.....	23
Checks before and after use .....	29
Running in.....	29
Refuelling.....	30
Oil mixer refuelling .....	31
Starting the engine .....	31
Engine shut-down .....	31
<b>CHAPTER 3 ADJUSTMENTS.....</b>	<b>33</b>
Key to symbols.....	34
Brakes .....	34
Clutch.....	34
Adjustment of gas clearance.....	35
Adjusting the idle speed.....	35
Exhaust valve control adjustment .....	38
Handlebar adjustment .....	38
Adjusting fork.....	39
Shock absorber.....	40
<b>CHAPTER 4 CHECKS AND MAINTENANCE .....</b>	<b>43</b>
Key to symbols.....	44
Engine oil.....	44
Liquid coolant .....	45
Air filter .....	48
Spark plug .....	49

Carburettor .....	50
Front brake.....	52
Rear brake .....	55
Clutch control .....	58
Check and adjusting of steering play.....	60
Front wheel .....	61
Fork.....	62
Rear suspension leverage.....	62
Tyres.....	63
Chain .....	63
Headlight.....	65
Replacing the headlight bulbs.....	65
Tail light.....	65
Battery.....	66
Fuses .....	68
Cleaning the vehicle.....	69
Prolonged inactivity.....	70
Scheduled maintenance vehicle .....	71
Tightening torque overview .....	73
<b>CHAPTER 5 REPLACEMENTS .....</b>	<b>75</b>
Removal and refitting of the saddle.....	76
Removing and installing air filter cover panel.....	77
<b>CHAPTER 6 TROUBLESHOOTING .....</b>	<b>79</b>
Troubleshooting .....	80











## OPERATING INSTRUCTIONS

- The vehicle must be accompanied by: number-plate, registration document, tax disc and insurance.
- Any modifications of the engine or other parts are punishable by severe sanctions including the confiscation of the vehicle.
- To protect your safety and that of others, always drive carefully and with your helmet on and always keep low beams on.
- Do not sit on the vehicle when it is on its stand.
- Do not start the engine in closed places.

### WARNING

Any modifications and tampering with the vehicle during the warranty period exempt the manufacturer from all responsibility and invalidate warranty.

## SYMBOLS

-  SAFETY/ATTENTION  
Failure to respect information marked with this symbol can entail a personal hazard.
-  INTEGRITY OF THE VEHICLE  
Failure to respect information marked with this symbol can entail serious damage to the vehicle and termination of the warranty.
-  FLAMMABLE LIQUID HAZARD
-  Read the use and maintenance manual carefully.
-  MANDATORY TO WEAR PROTECTIVE CLOTHING  
Use of the vehicle is subject to wearing specific protective clothing and safety footwear.
-  PROTECTIVE GLOVES MANDATORY  
To perform the operations described, it is mandatory to wear protective gloves.
-  FORBIDDEN TO USE NAKED FLAMES OR POSSIBLE UNCONTROLLED IGNITION SOURCES
-  NO SMOKING
-  DO NOT USE MOBILE PHONE
-  CORROSIVE SUBSTANCES HAZARD  
Liquids marked with this symbol are highly corrosive: handle with care
-  POISONING HAZARD

## RIDING SAFETY

- Observe the Highway Code.
- Always wear approved personal protective equipment.
- Always ride with the low beam on.
- Always keep the crash helmet visor clean.
- Avoid wearing garments with hanging ends.
- Do not keep sharp or brittle objects in your pockets while riding.
- Properly adjust the rearview mirrors.
- Always ride in a seated position, with both hands on the handlebars and both feet on the footrests.
- Never ride abreast with other vehicles.
- Do not tow and avoid being towed by other vehicles.
- Always keep a safe distance from other vehicles.
- Do not start off while the vehicle is on its stand.
- Avoid swaying and wheelies as they are extremely dangerous for your own and other people's safety as well as for your vehicle.
- Always apply both brakes on dry roads with no gravel and sand. Using one brake may be dangerous and cause uncontrolled skidding.
- To reduce the braking distance, always apply both brakes.
- On wet roads and in off-road riding, drive with care and at moderate speed. Take special care in applying the brakes.

**CHAPTER 1 GENERAL INFORMATION**

## CONTENTS

Vehicle identification data .....	8
Frame identification .....	8
Engine identification .....	8
Tools kit .....	8
Familiarizing with the vehicle.....	9
Main parts:.....	9
Specifications .....	10
Weight.....	10
Dimensions .....	10
Tyres .....	10
Capacities .....	10
Front suspension.....	11
Rear suspension .....	11
Front brake .....	11
Rear brake .....	11
Engine .....	12
Electrical system.....	14
Electrical diagram .....	14
Legend electrical diagram .....	15
Recommended lubricants and liquid .....	16

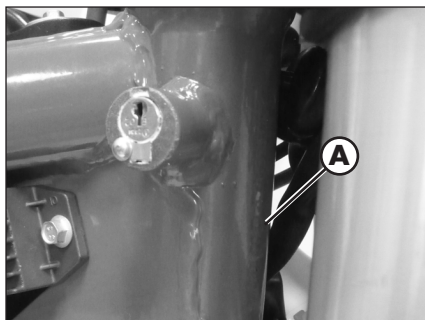

## VEHICLE IDENTIFICATION DATA

### FRAME IDENTIFICATION

Frame identification data **A** are stamped on the right side of the steering head tube.

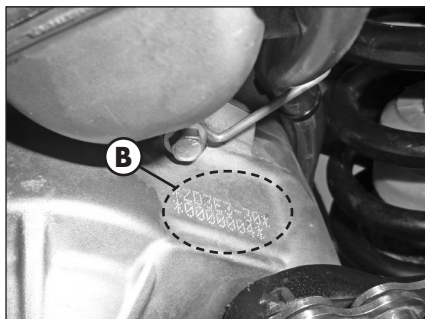

### ENGINE IDENTIFICATION

Engine identification data **B** are stamped in the area shown in the figure.

## TOOLS KIT

The following items are supplied as standard: operation and maintenance manual, tool kit.

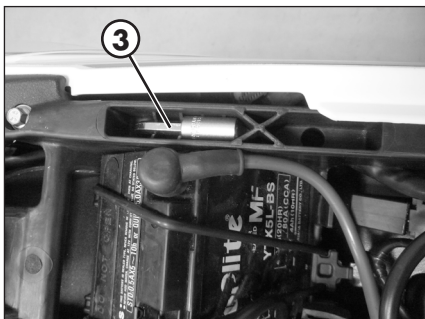

Inside the battery compartment you will find the hexagon wrench 3 and the socket wrench (8 mm). To gain access remove the saddle (page 76).



## FAMILIARIZING WITH THE VEHICLE

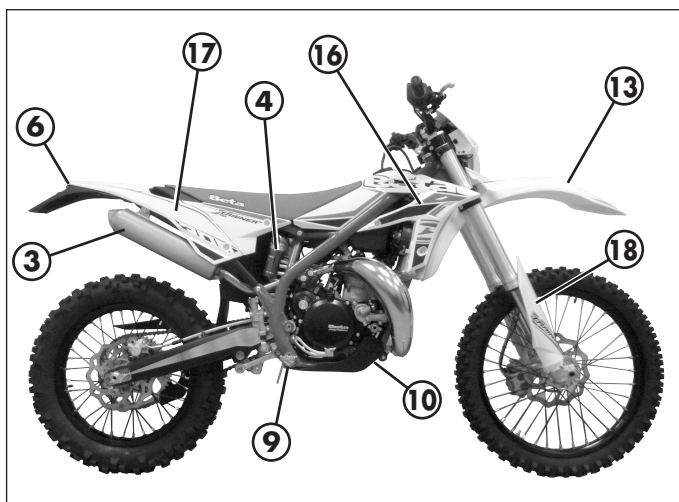
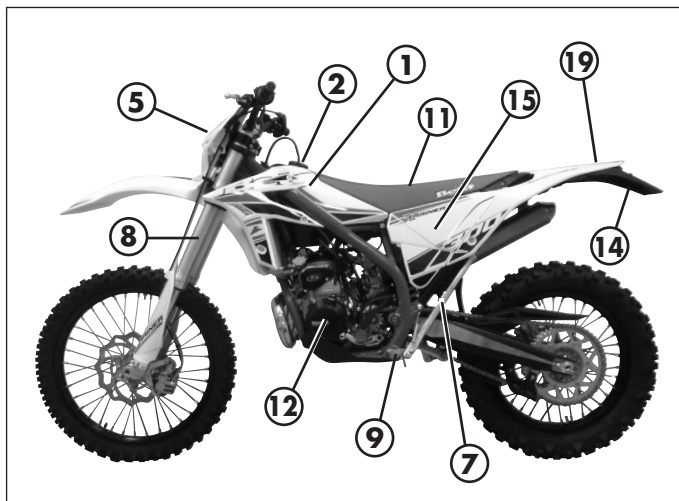

### MAIN PARTS:

- |                         |                                     |                      |
|-------------------------|-------------------------------------|----------------------|
| 1 - Fuel tank           | 10 - Lower bumper<br>(Bumper kit)   | 17 - Rear side panel |
| 2 - Tank cap            | 11 - Saddle                         | 18 - Fork covers     |
| 3 - Silencer            | 12 - Engine                         | 19 - Rear mudguard   |
| 4 - Rear shock absorber | 13 - Front mudguard                 |                      |
| 5 - Headlight           | 14 - Number-plate holder            |                      |
| 6 - Rear light          | 15 - Side panel air filter<br>cover |                      |
| 7 - Side stand          | 16 - Front side panel               |                      |
| 8 - Fork                |                                     |                      |
| 9 - Rider's footrests   |                                     |                      |

# 1

## SPECIFICATIONS

### WEIGHT

Dry weight ..... 99 kg (front 48 Kg; rear 51 Kg)

### DIMENSIONS

maximum length..... 2157 mm  
 maximum width ..... 802 mm  
 overall height ..... 1245 mm  
 wheelbase..... 1467 mm  
 saddle height..... 910 mm  
 ground clearance..... 320 mm  
 footrest height..... 390 mm

### TYRES

Dimensions		Pressure [Bar]	
Front tyre	Rear tyre	Front tyre	Rear tyre
80/100-21	140/80-18	1,5 (road use)	1,8 (road use)
		1 (off-road use)	1 (off-road use)

### CAPACITIES

fuel tank.....8,5 liters  
 including reserve.....1,5 liters  
 coolant circuit.....1,3 liters  
 mixer oil tank .....0,55 liters  
 including reserve.....0,21 liters  
 gear oil.....0,85 liters

**FRONT SUSPENSION**

Hydraulic fork USD (shafts Ø43 mm)

Spring .....	K 8
Oil type .....	see table "Recommended lubricants and liquids", page 16
Oil quantity .....	500 ml
Spring preload register .....	completely open
Rebound clicks (from completely closed).....	12
Wheel travel.....	270 mm

**REAR SUSPENSION**

Single shock absorber with compound lever

Spring .....	K 5,2
Static sag load (see page 41).....	22 mm
Compression clicks, high speeds (from completely closed).....	15
Rebound clicks (from completely closed).....	10
Shock absorber travel.....	110 mm

**FRONT BRAKE**

Ø260 mm disc and dual-piston floating caliper

**REAR BRAKE**

Ø240 mm disc and single-piston floating caliper

# 1

## ENGINE

Type ..... Single-cylinder, 2-stroke, liquid cooled and electric start

Bore x stroke ..... 72 x 72 mm

Displacement (cm<sup>3</sup>) ..... 293,1 cm<sup>3</sup>

Compression ratio ..... 11,3:1

Fuel system ..... carburettor with electronic mixer

Carburettor

<b>X-TRAINER 300</b>		
Version	Certif.	Competition*
Carburettor type	PWK 36S AG	
Main jet	118	155
Slow jet	38	35
Start jet	50	85
Needle	N84K	N1EJ
Needle position (from top)	4°	2°
Air screw turns (from all closed)	1	1+1/2
Valve	7,5	
Striker	YES	NO

\* - Such modification makes the vehicle non-compliant with the road regulations in force. Its use must be limited to the sole private circuits which are closed to circulation.

Cooling system ..... forced liquid circulation by pump

Spark plug ..... NGK IR GR7CI-8

Clutch ..... wet, multidisc

## Gearchange

Version	X-TRAINER 300	
Primary drive	28/70	
Gear ratio 1 <sup>st</sup> gear	12/31	
Gear ratio 2 <sup>nd</sup> gear	15/28	
Gear ratio 3 <sup>rd</sup> gear	19/28	
Gear ratio 4 <sup>th</sup> gear	20/24	
Gear ratio 5 <sup>th</sup> gear	27/27	
Gear ratio 6 <sup>th</sup> gear	28/24	
Final drive	Certif.	Competition*
	15/45	13/51

\* - Such modification makes the vehicle non-compliant with the road regulations in force. Its use must be limited to the sole private circuits which are closed to circulation.

Exhaust valve.....centrifugal operation with reaction springs

Ignition ..... DC-CDI without trembler,  
with digital variable spark advance, Kokusan-type

Starting..... electric starter

# ELECTRICAL SYSTEM

## ELECTRICAL DIAGRAM

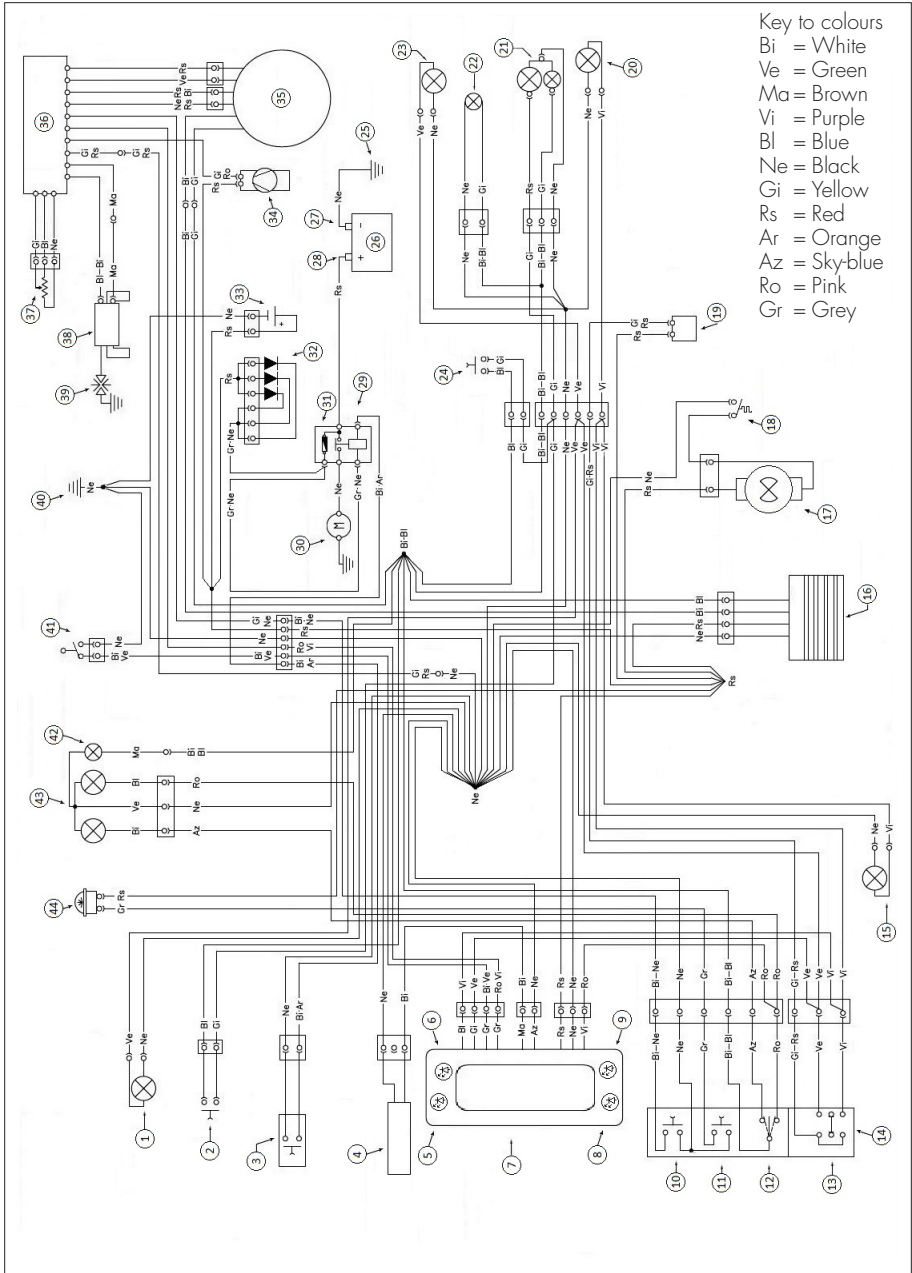

**LEGEND ELECTRICAL DIAGRAM**

- 1) RIGHTHAND FRONT TURN INDICATOR 12V 6W
- 2) FRONT BRAKE LIGHT BUTTON
- 3) START BUTTON
- 4) WHEEL REVOLUTION SENSOR
- 5) TURN INDICATORS WARNING LIGHT
- 6) OIL RESERVE WARNING LIGHT
- 7) DASHBOARD
- 8) HEADLIGHT TELL TALE LAMP
- 9) MIXER DIAGNOSIS WARNING LIGHT
- 10) ENGINE STOP BUTTON
- 11) HORN BUTTON
- 12) HEADLIGHT SELECTOR
- 13) TURN SIGNAL LAMPS SWITCH
- 14) LEFT-HAND CONTROL GROUP
- 15) LEFT-HAND FRONT TURN INDICATOR 12V 6W
- 16) REGULATOR
- 17) ELECTRIC FAN
- 18) THERMOSWITCH
- 19) UNIT TURN SIGNAL LAMPS
- 20) LEFT-HAND REAR TURN INDICATOR (12V 6W BULB)
- 21) TAIL LIGHT WITH LED
- 22) NUMBER-PLATE LIGHT
- 23) RIGHTHAND REAR TURN INDICATOR (12V 6W BULB)
- 24) REAR STOP BUTTON
- 25) FRAME EARTH
- 26) BATTERY 12V 4AH
- 27) BATTERY NEGATIVE TERMINAL
- 28) BATTERY POSITIVE TERMINAL
- 29) STARTER RELAY
- 30) STARTER MOTOR
- 31) 10A FUSE
- 32) CHARGER DIODES GROUP
- 33) CONDENSATOR 4700  $\mu$ F
- 34) MIXER OIL PUMP
- 35) GENERATOR
- 36) ELECTRONIC CONTROL UNIT
- 37) TPS
- 38) HT COIL
- 39) SPARK PLUG
- 40) FRAME EARTH
- 41) OIL RESERVE SENSOR
- 42) PARKING LIGHT 12V 5W
- 43) HEADLIGHT (12V-35/35W BULB)
- 44) 12V HORN

# 1

## RECOMMENDED LUBRICANTS AND LIQUID

To maximize the vehicle's performance and ensure many years of trouble-free operation, we recommend using the following products:

<b>PRODUCT TYPE</b>	<b>SPECIFICATIONS</b>
OIL MIXER TANK	LIQUI MOLY 2-STROKE MOTOR OIL, SELF-MIXING
GEAR AND CLUTCH OIL	LIQUI MOLY RACING 10W40
BRAKE OIL	LIQUI MOLY BRAKE FLUID DOT 5.1
CLUTCH ACTUATOR OIL	LIQUI MOLY BRAKE FLUID DOT 5.1
FORK OIL	SAE 5W
TIE ROD GREASE	LIQUI MOLY SCHMIERFIX
LIQUID COOLANT	LIQUI MOLY COOLANT READY MIX RAF12 PLUS

Note:

It is essential that all renewals should be performed with the products listed in the table above.



**CHAPTER 2 OPERATION**

## CONTENTS

Main parts .....	18
Fuel tank cap .....	18
Fuel cock.....	18
Starter.....	19
Mixer oil tank cap .....	19
Clutch lever .....	19
LH switch.....	20
Starter button .....	20
Front brake lever and gas control .....	20
Gear change lever.....	21
Brake pedal.....	21
Side stand .....	21
Keys .....	21
Steering lock.....	22
Digital rpm indicator operating instructions.....	23
Checks before and after use .....	29
Running in.....	29
Refuelling .....	30
Oil mixer refuelling .....	31
Starting the engine .....	31
Engine shut-down .....	31

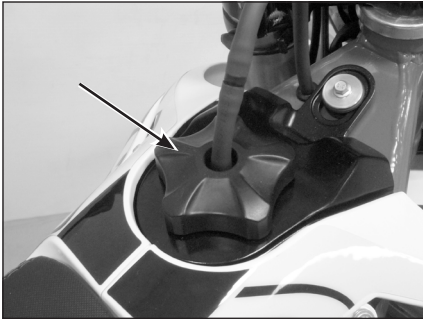

## MAIN PARTS

### FUEL TANK CAP

To open the fuel tank cap, turn it anticlockwise.

To close the fuel tank cap, set it on the tank and screw it clockwise.

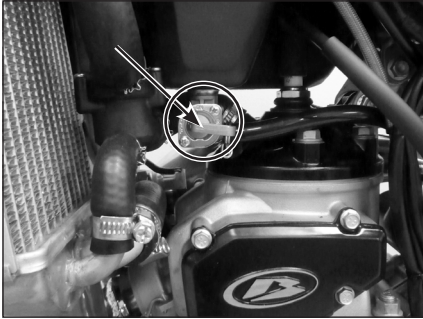

### FUEL COCK

Fuel cock has three positions:

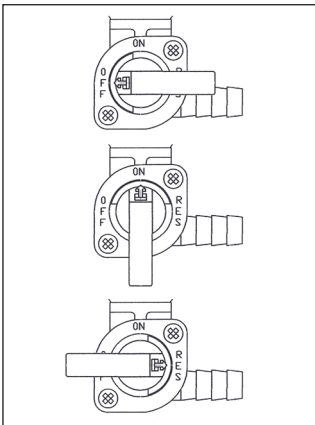

**OFF:** fuel supply closed. Fuel cannot pass from the tank to the carburettor.

**ON:** fuel supply enabled. Fuel flows from the tank to the carburettor. The tank empties until it reaches the reserve level.

**RES:** reserve fuel supply. Fuel flows from the tank to the carburettor and the tank empties completely.

## STARTER

The starter lever is located on the carburettor.

To operate the choke pull it upward.

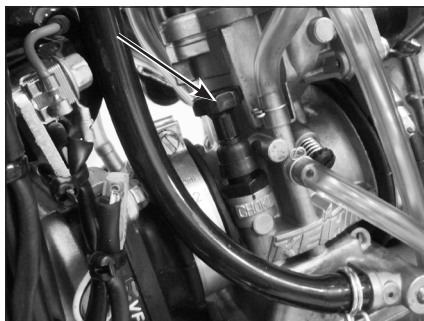

## MIXER OIL TANK CAP

The mixer oil tank cap is located under the saddle.

To gain access remove the saddle (page 76).



To open the fuel tank cap turn it anticlockwise.

To close the fuel tank cap, set it on the tank and screw it clockwise.

## CLUTCH LEVER

Clutch lever is fitted to the left-hand side of the handlebars.

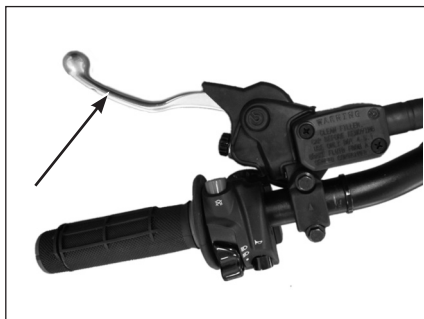

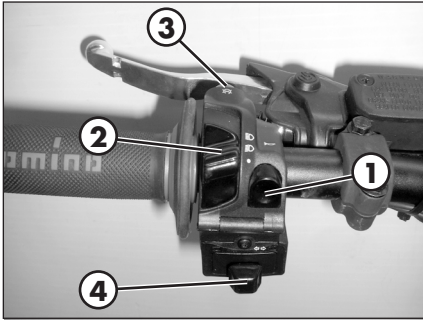

## LH SWITCH

The dip and service switch is located on the left side of the handlebar and is composed as follows:

- 1** - Horn button;
- 2** - Dip switch:
  - only parking lights;
  - ☰ parking lights and high beam;
  - ☷ parking lights and low beam;
- 3** - Shut-down : press the button until the engine stops;
- 4** - Turn signal light switch: shifting lever left or right activates the left or right indicators. When released, the lever returns to the central position. Press it to turn the indicators off.

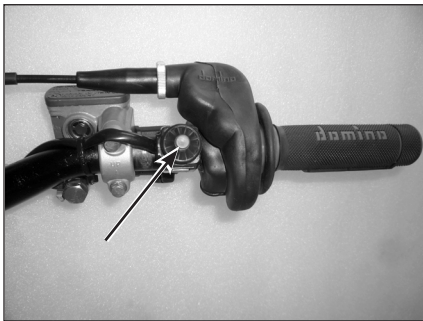

## STARTER BUTTON

Starter button is located on the right-hand side of the handlebars and operate the electric engine starter. Push the button until the engine starts.

Do not press the button while the engine is running.

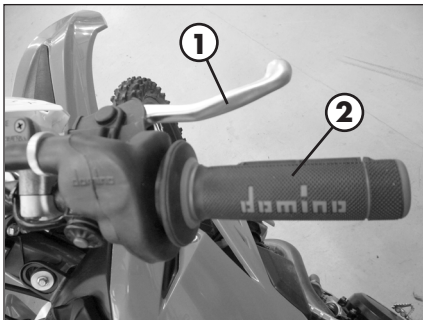

## FRONT BRAKE LEVER AND GAS CONTROL

The front brake lever **1** and the gas throttle **2** are located on the right side of the handlebar.

## GEAR CHANGE LEVER

Gear change lever is fitted to the left side of the engine.  
The positions corresponding to the different gears are shown in the figure.

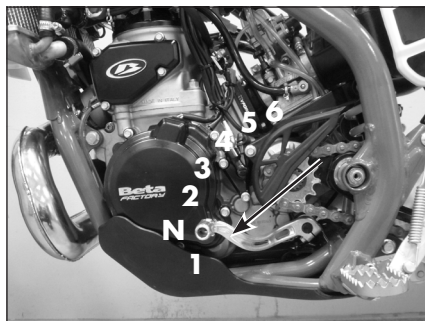

## BRAKE PEDAL

Brake pedal is located in front of the right-hand footrest.

The rear brake is operated by pressing down the pedal.

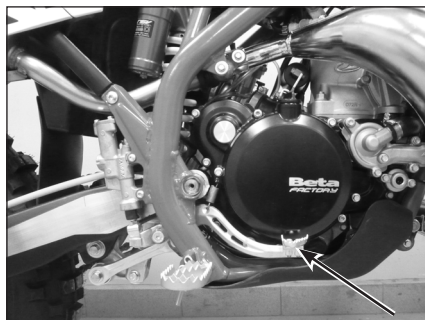

## SIDE STAND

Press down side stand with the foot and lean the vehicle against it.  
Ensure that the ground is solid and the vehicle stands steadily.



## KEYS

The vehicle is supplied with two keys (one key and its spare).

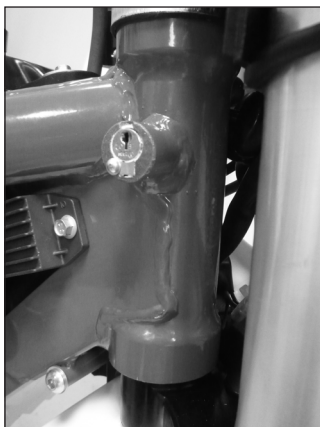

## STEERING LOCK

To activate the steering lock:

- turn the handlebar counter-clockwise;
- push the key and turn counter-clockwise;

Remove the key from this position.

The engine can not be started.

To deactivate the steering lock:

- turn the key clockwise;
- turn the handlebar clockwise;

From this position, the handlebar is free to move, the key can be removed and the engine can not be started.

**WARNING:** do not keep the spare key inside the vehicle, but in a safe place.

We suggest you note the code number stamped on the keys. In this way you can obtain a duplicate.

## DIGITAL RPM INDICATOR OPERATING INSTRUCTIONS

### Contents

- 1 GENERAL SPECIFICATIONS AND GENERAL INFORMATIONS
  - 1.1 General specifications
  - 1.2 General informations
- 2 SETTING THE PARAMETERS
  - 2.1 Setup sequence
    - 2.1.1 Selecting the unit of measure
    - 2.1.2 Selecting the wheel size
    - 2.1.3 Selecting the clock format
    - 2.1.4 Setting the Time
    - 2.1.5 Selecting the maintenance memo
- 3 SCREENS
- 4 FEATURES
- 5 SPEEDOMETER
- 6 ADJUSTING THE TRAVELLED DISTANCE METER
- 7 WARNING LIGHTS

### 1 GENERAL SPECIFICATIONS AND GENERAL INFORMATIONS

#### 1.1 GENERAL SPECIFICATIONS

SPEED/DISTANCE SENSOR: Non-contact magnetic

DISPLAY MEASUREMENTS: 125mm x 41mm x 34mm

STORAGE TEMPERATURE: -20°C to 80°C (-4°F to 176°F)

BATTERY: 3V CR2032

BATTERY LIFE: Approximately one year

EXTERNAL CURRENT SUPPLY: 12V DC

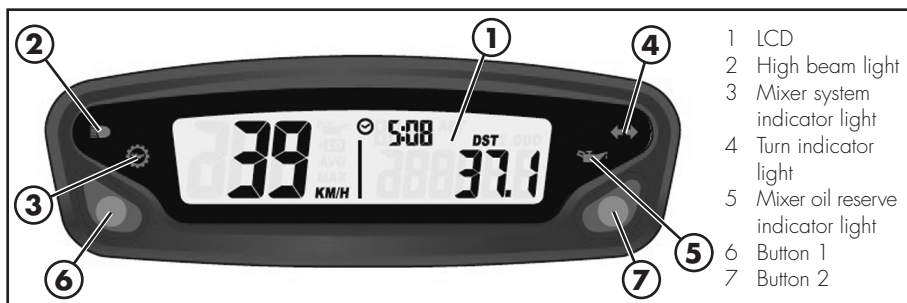

#### 1.2 GENERAL INFORMATIONS

Backlight:

The digital speedometer/odometer is backlit to enable reading where there is poor or no lighting.

When using supplied power with the engine on:

- The back-lighting is on permanently when the engine is running.

Using only the internal battery:

- With the LO symbol, the backlighting will not switch on. The **LO** symbol appears when the battery voltage is lower than 2.45V.

Reset Button:

Using the Reset button, located on the back of the instrument, all travel data will be deleted, including date and time.

Internal battery:

The instrument houses a 3.0V internal button cell battery (CR2032). The instrument can only work with this battery. The **LO** symbol appears when the battery is running low. To change the battery, unscrew the cap located on the back of the instrument using a coin.

Once the battery has been changed, make sure that the positive side is facing outwards.

### REPLACE THE BATTERY WITH ANOTHER CR2032-TYPE BATTERY.

## 2 SETTING THE PARAMETERS

General information:

Allowed settings:

- Km/h (kilometres per hour) or M/h (Miles per hour)
- Wheel size (rolling circumference) [mm]
- Clock format: 12-hour / 24-hour
- Current date
- Maintenance

TO ENTER THE PARAMETER SETTINGS MODE HOLD DOWN THE RIGHT AND LEFT BUTTONS FOR APPROX. 3s.

THE WORD "Unit" WILL FLASH ON THE DISPLAY.

The operational logic is structured as follows:

- The instrument enters SETUP mode displaying the parameters according to the sequence listed above.
- The instrument displays the parameter to be changed for a few seconds in flash mode.
- If you wish to change the parameter displayed for those few seconds simply edit the values by pressing the right and/or left buttons (according to the modes listed below), otherwise wait a few seconds (approx. 5 s) to proceed to the next parameter.
- When the parameter has been edited to the desired value, the instrument automatically moves onto the next setting, there is no need to press any button of confirmation.
- If you only wish to enter the setup mode to view the configured settings, simply wait without pressing any buttons; the instrument will display all of the set parameters and will then automatically go back to "Normal Mode".



## 2.1 SETUP SEQUENCE

Select unit of measure

Wheel size

Clock format

Setting the Time

Maintenance reminder

2.1.1 Selecting the unit of measure (Km/h or M/h):

TO SELECT THE UNIT OF MEASURE (Km/h or M/h), PRESS THE RIGHT OR LEFT BUTTON.

WAIT 5 SECONDS TO PROCEED TO THE NEXT SETTING.

DO NOT PRESS ANY BUTTONS.

2.1.2 Selecting the wheel size (rolling circumference):

The instrument has programmed two rolling circumference measurements for the front wheel: larger size (ENDURO tyre) or smaller size (ALL TERRAIN tyre).

PRESS THE LEFT BUTTON TO SELECT ONE OF THE TWO OPTIONS.

WAIT 5 SECONDS TO PROCEED TO THE NEXT SETTING. DO NOT PRESS ANY BUTTONS.

2.1.3 Selecting the clock format (12- or 24-hour):

The default setting on the instrument is the 12-hour clock.

TO SELECT THE 12- OR 24-HOUR CLOCK, PRESS THE RIGHT OR LEFT BUTTON.

WAIT 5 SECONDS TO PROCEED TO THE NEXT SETTING. DO NOT PRESS ANY BUTTONS.

2.1.4 Setting the Time:

The time is set by increasing or decreasing it by 1 minute steps.

PRESS THE LEFT BUTTON TO DECREASE THE TIME.

PRESS THE RIGHT BUTTON TO INCREASE IT.

WAIT 5 SECONDS TO PROCEED TO THE NEXT SETTING. DO NOT PRESS ANY BUTTONS.

2.1.5 Selecting the maintenance reminder 

The instrument displays the countdown to maintenance operations based on the data entered by the user. The data is based on the kilometres and miles travelled according to the unit of measure selected by the user. The factory setting is on "OFF". PRESS THE LEFT BUTTON TO LOWER THE NUMBER. PRESS THE RIGHT BUTTON TO RAISE IT (max value 10000Km).

WAIT 5 SECONDS TO EXIT SETUP MODE.

DO NOT PRESS ANY BUTTONS.

## 3 SCREENS

Switching between 3 normal modes

All of the information that the instrument is capable of providing is displayed on one of these 3 screens.

The instrument will stay on the set screen until a button is pressed to switch to another screen.

TO SWITCH FROM ONE SCREEN TO ANOTHER, PRESS EITHER THE RIGHT OR LEFT BUTTON BRIEFLY.

Screen 1:

- Speed • Distance 1 (DST) • Time

Screen 2:

- Speed • Distance 2 (DST2) • Time

Screen 3:

- Maximum speed (MAX) • Average speed (AVG)
- Accumulated running time (ART) • Odometer (ODO)

\* Note: The maximum and average speeds are updated automatically when the user accesses screen 3.

## 4 FEATURES

General information:

During normal use the instrument is in "Normal" mode.

Available modes:

- Sleep Mode
- Choose from 3 "Normal" screens
- Clear Distance 1 (DST1)
- Clear Distance 2 (DST2)
- Clear Maximum/Average Speed (MAX/AVG)

Sleep Mode:

If the instrument does not receive any input for 5 minutes (either from the movement of the wheel or a button), it will go into "Sleep Mode". In "Sleep Mode" only the time appears on the screen.

To exit "Sleep Mode" all the instrument requires is an input, either from the movement of the sensor or by pressing a button.

## 5 SPEEDOMETER

### Speed

The speed is displayed in the centre of screens 1 or 2 and can range from 0 to 399.9 km/h or M/h. The unit of measure (km/h or M/h) appears next to the speed reading.



### Maximum (Max) and Average (AVG) speed

The Maximum (MAX) or Average (AVG) speeds are displayed on screen 3 to the left of the display. The instrument automatically updates both the maximum (MAX) and average (AVG) speeds. To clear the maximum (MAX) and average (AVG) speeds, hold the right button down for 5 seconds.

Note: you must be on screen 3 to clear the speeds.



## 6 ADJUSTING THE TRAVELLED DISTANCE METER

### Description

The travelled distance meter displays the distance that has been travelled since it was last cleared. It has two different distinguishing distances.



# 2

## Travelled distance (DST)

The travelled distance can range from 0 to 9999.9 miles or kilometers and appears on the right side of screen 1. To clear the travelled distance, hold the right button down for 5 seconds.

Note: you must be on screen 1 to clear the travelled distance.



## Travelled distance 2 (DST 2)

Travelled distance 2 can range from 0 to 9999.9 miles or kilometers and appears on the right side of screen 2. To clear the travelled distance, hold the right button down for 5 seconds.

Note: you must be on screen 2 to clear the travelled distance.



# OPERATION

## 7 WARNING LIGHTS



### 7.1 Headlight indicator **1**

The system activates the indicator in synchrony with the activation of the mains beams.

### 7.2 Direction indicator lights **2**

The system activates the indicator in synchrony with the activation of the direction indicators.

### 7.3 Mixer system indicator light **3**

When you start the vehicle, the system performs a diagnosis check, while the indicator lights for 10 seconds (check). If the indicator comes on during normal operation, or the start check failure, they indicate a fault in the mixer system.

If the indicator comes on during normal operation, it indicates a fault in the mixer system. In this case stop the engine immediately, empty the fuel tank and refuel with mixture at 1.6%. Then go to an authorized Betamotor service as soon as possible.

### 7.4 Mixer oil reserve indicator light **4**

If the warning light comes on, refuel as soon as possible. The mixer tank reserve is indicated on page 10. Refuel with special oil as indicated in the "Table of Lubricants and Recommended Liquids" on page 16.

## CHECKS BEFORE AND AFTER USE

For safe driving and long vehicle life you should:

- 1 Check the integrity of the oil pipe connecting the intake manifold to the electronic dosing.
- 2 Check all fluid levels.
- 3 Check the correct operation of the brakes and brake pad wear (page 54).
- 4 Check pressure, general condition and thickness of tread (page 63).
- 5 Check that the spokes are properly tightened.
- 6 Check the tensioning of the chain (page 63).
- 7 Check the adjustment and the operation of all the cable controls.
- 8 Inspect all the nuts and bolts.
- 9 With the engine running, check the operation of the headlight, the rear and brake lights, the indicators, the warning lights and the horn.
- 10 Wash the motorcycle thoroughly after off-road use (page 69).

## RUNNING IN

The running-in period lasts approximately 15 hours, during which it is advisable to:

- 1 Make the first refuelling with a mixture of 1%.
- 2 Use the oil indicated on page 16 in the "Recommended lubricants and liquids" table.
- 3 During the first 3 hours of operation the engine should only be used to approximately 70 percent of its power. In addition, the engine speed should not exceed 7,000 rpm.
- 4 For the next 2 hours of operation the engine should only be used to about 90 percent of its power.
- 5 Use the vehicle after properly warming up the engine.
- 6 Avoid travelling at constant speed (changing the speed causes the different components to bed in evenly and more quickly).

This procedure should be followed each time piston, piston rings, cylinder, crankshaft or crankshaft bearings are replaced.

### WARNING

Replace the transmission oil after the first 3 hours or after 15 l. of mixture.

# 2 REFUELLING

Use unleaded petrol.

Fuel tank capacity is shown on page 10.

To refuel open the tank cap (page 18).

After refuelling, screw the cap back and tighten securely.



**WARNING**

The refuelling should be performed with the engine off.



**WARNING:**

Fire hazard. Fuel is highly flammable.



Always stop the engine when refuelling and keep open flames and lighted cigarettes away.



Do not top up fuel while using a mobile phone.

Refuel in an open well ventilated area.

Pay special attention so that the fuel does not come into contact with hot parts of the vehicle. Immediately clean up any spilled fuel.



**WARNING:** Risk of poisoning.

Fuel is poisonous liquid and a health hazard.



Fuel must not come into contact with the skin, eyes, and clothing. Do not breathe in the fuel vapours. If contact occurs with the eyes, rinse immediately with plenty of water and seek medical advice. If contact occurs with skin, immediately clean contaminated areas with soap and water. If fuel is swallowed, contact a doctor immediately. Change clothing that is contaminated with fuel.

**WARNING:** Environmental pollution hazard.

The fuel must not contaminate the ground water, the ground, or the sewage system.

## OIL MIXER REFUELLING

To refuel open the tank cap (page 18).

Fuel tank capacity is shown on page 10.

After refuelling, screw the cap back and tighten securely.

Use the oil indicated on page 16 in the "Recommended lubricants and liquids" table.

## STARTING THE ENGINE

Move the fuel tank valve in **ON** or **RES** position (page 18).

Check that the gears are in neutral (page 21).

Pull the clutch lever (page 19).

Close the side stand (page 21).

WHIT ELECTRIC STARTER (page 20):

Push the button until the engine starts.

Do not press the button while the engine is running.

COLD STARTING:

Operate the starter (page 19), start the vehicle, wait a few seconds, then move the starter back to its starting position.

## ENGINE SHUT-DOWN

To shut-down the engine press the button  on the left switch unit (page 20).

NOTE:

With the engine off, make sure the fuel cock is set to OFF (page 18).





**CHAPTER 3 ADJUSTMENTS**

## CONTENTS

Key to symbols.....	34
Brakes .....	34
Front brake .....	34
Rear brake .....	34
Clutch.....	34
Adjustment of gas clearance.....	35
Adjusting the idle speed.....	35
Carburetor settings according to the working conditions.....	36
Exhaust valve control adjustment .....	38
Handlebar adjustment .....	38
U-bolt position adjustment.....	38
Adjustment of the handlebar position .....	39
Adjusting fork.....	39
Adjusting the rebound damper .....	39
Adjusting the spring preload .....	39
Shock absorber.....	40
Adjusting the rebound damper .....	40
Adjusting the hydraulic compression damper .....	40
Adjusting the spring preload.....	41
Static sag load test .....	41

## KEY TO SYMBOLS



Tightening torque



Threadlocker Medium

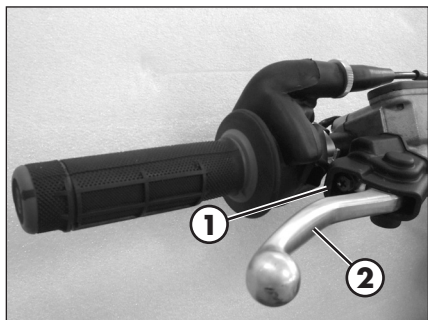

## BRAKES

### FRONT BRAKE

The front brake is disk type with hydraulic control.

The home position of brake lever **2** can be adjusted by means of screw **1**.

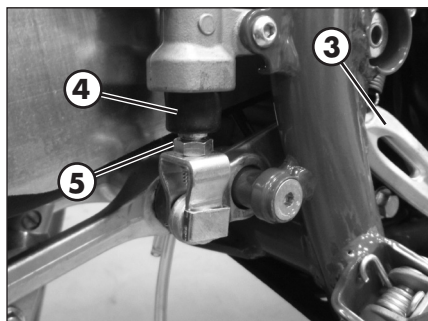

### REAR BRAKE

The home position of brake pedal **3** can be altered by turning adjusting screw **5** after loosening the counternut located under dust cap **4**. Loosen the counternut and turn the adjusting screw until the desired height is obtained. Retighten the counternut after completing the operation.

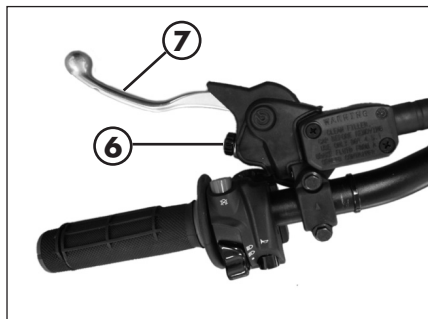

## CLUTCH

The adjustment screw **6** allows adjustment of the distance of lever **7** from the knob. The empty run is recovered automatically.

## ADJUSTMENT OF GAS CLEARANCE

The throttle control cable should always have a 3-5 mm play. In addition, the idle speed should not change when the handlebars are fully rotated to the left or right. Push back protective cap **1**. Loosen counternut **2** and turn adjusting screw **3**. Tighten the counternut and check that the throttle twist grip turns smoothly.

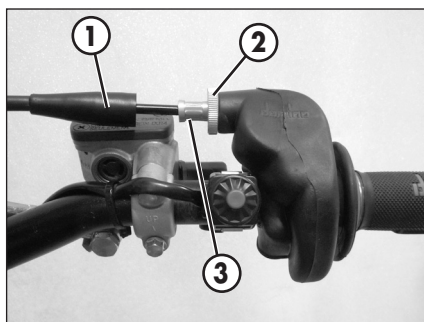

## ADJUSTING THE IDLE SPEED

Idling adjustment greatly affects the appropriate start-up and the accelerator response.

Idling is adjusted through adjustment screw **1** and air adjustment screw **2**. Adjustment screw **1** adjusts the basis position of the gas valve. Turn the screw clockwise to increase the rotation conditions and counterclockwise to diminish it. The air adjustment screw **2** adjusts the quantity of which is mixed to the fuel for idling. If the screw is turned counterclockwise, the quantity of air increases (thin mix), if turned clockwise, the quantity of air diminishes (fat mix).

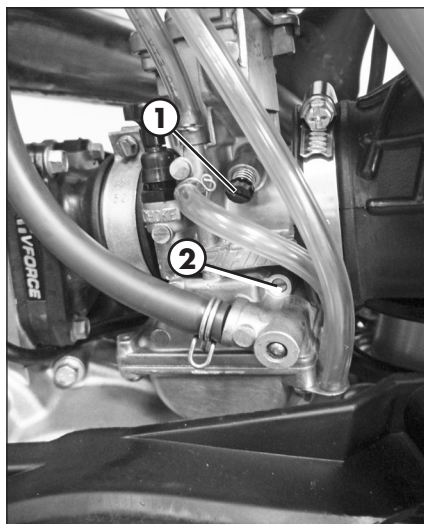

To properly adjust the idle speed, follow these steps:

- Tighten the air adjustment screw no. 2 fully and then loosen it up to the value described in the carburetor setting table (page 12)
- Warm the engine for approx. 5 minutes, until the operational temperature is attained.
- Slowly turn the air adjustment screw **2** clockwise, until idling starts diminishing.
- Mark the position, then slowly turn the air adjustment screw no. **2** counterclockwise, until idling decreases again.
- Adjust the screw between these two positions, at the highest idling point..

If a remarkable increase in the rpm occurred during the adjustment above, idling is to be reduced and taken back to the normal level, and then execute the above procedure.

If no satisfactory results are obtained after the procedure, this may be due to an incorrect slow-running jet.

If the air adjustment screw has been thoroughly tightened, but the rpm have not varied, a lower size slow-running jet is to be used.

Execute the adjustment procedure again after replacing the jet.

NOTE:

The correct idling should be between 1500 and 1600 rpm.





### **CARBURETOR SETTINGS ACCORDING TO THE WORKING CONDITIONS**

See the following tables to adjust the carburetor settings according to ambient temperature and altitude.

Legend:

SUM	Above sea level
AVA	Air screw opening (from all closed)
Gm	Slow jet
SPL	Needle
POS	Needle position (from top)
GM	Main jet
VLV	Valve

Standard settings

Altitude (SLM)	Carburetor setting	Ambient temperature						
		-20°C ÷ ÷-7°C	-6°C ÷ 5°C	6°C ÷ 15°C	16°C ÷ 24°C	25°C ÷ 36°C	37°C ÷ 49°C	
		-2°F ÷ 20°F	19°F ÷ 41°F	42°F ÷ 60°F	61°F ÷ 78°F	79°F ÷ 98°F	99°F ÷ 120°F	
3000 m 10000 ft 	AVA	1,5	2	2	2,5	2,5		
	Gm	35	35	35	35	35		
	GM	155	152	150	148	145		
	SPL	N1EJ	N1EJ	N1EK	N1EK	N1EK		
	2301 m 7501 ft	POS	2	2	1	1	1	
	VLV	7,5	7,5	7,5	7,5	7,5		
2300 m 7500 ft 	AVA	1,5	1,5	2	2	2,5	2,5	
	Gm	38	35	35	35	35	35	
	GM	158	155	152	150	148	145	
	SPL	N1EJ	N1EJ	N1EJ	N1EK	N1EK	N1EK	
	1501 m 5001 ft	POS	2	2	2	1	1	1
	VLV	7,5	7,5	7,5	7,5	7,5	7,5	
1500 m 5000 ft 	AVA	1,5	1,5	1,5	2	2	2,5	
	Gm	38	38	35	35	35	35	
	GM	160	158	155	152	150	148	
	SPL	N1EI	N1EJ	N1EJ	N1EJ	N1EK	N1EK	
	751 m 2501 ft	POS	2	2	2	2	1	1
	VLV	7,5	7,5	7,5	7,5	7,5	7,5	
750 m 2500 ft 	AVA	1,5	1,5	1,5	1,5	2	2	
	Gm	40	38	38	35	35	35	
	GM	162	160	158	155	152	150	
	SPL	N1EI	N1EI	N1EJ	N1EJ	N1EJ	N1EK	
	301 m 1001 ft	POS	3	2	2	2	2	1
	VLV	7,5	7,5	7,5	7,5	7,5	7,5	
300 m 1000 ft 	AVA	1	1,5	1,5	1,5	1,5	2	
	Gm	40	40	38	38	35	35	
	GM	165	162	160	158	155	152	
	SPL	N1EH	N1EI	N1EI	N1EJ	N1EJ	N1EJ	
	0 m 0 ft	POS	4	3	2	2	2	2
	VLV	7,5	7,5	7,5	7,5	7,5	7,5	

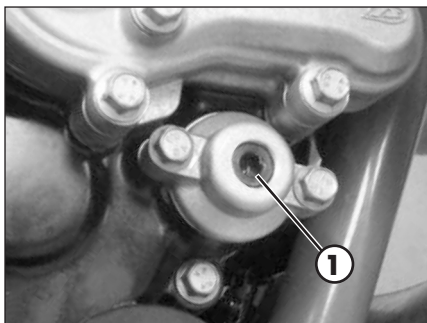

## EXHAUST VALVE CONTROL ADJUSTMENT

ATTENTION! The vehicle is provided with an exhaust valve whose fine tuning is performed during the final try-out of the engine. The position of adjustment valve 1 must not be modified for any reason.

For any adjusting, please contact Betamotor's Authorized Service Network.

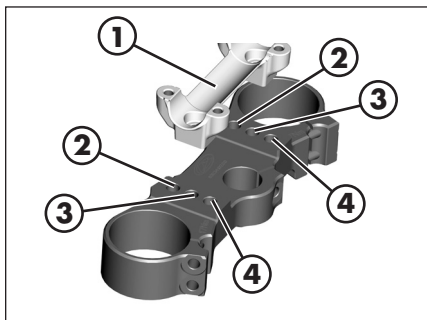

## HANDLEBAR ADJUSTMENT

### U-BOLT POSITION ADJUSTMENT

The lower bracket 1 can be mounted in correspondence of the holes nr. 2, 3 or 4 respectively.

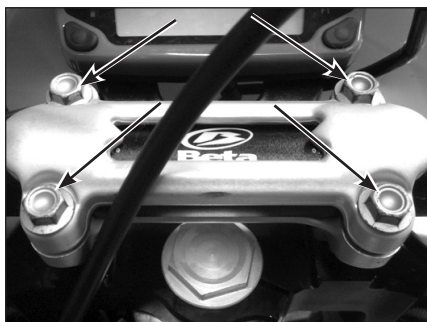

To adjust the position of the u-bolt remove the screws shown in the figure.

Remove the handlebar.

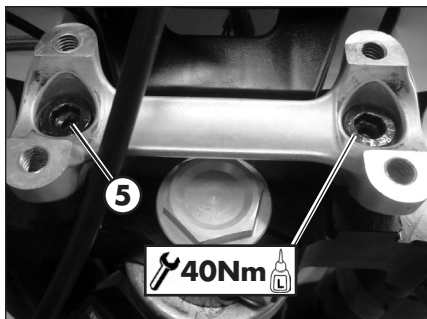

Remove the screws 5.

Position the U-bolt according to requirements.

At the end refit the screws 5 after the application of thread lock fluid and tighten to the torque indicated.

Apply the handlebar.

Apply the top u-bolt.

Refit the screws **6**. Tighten to the torque indicated.

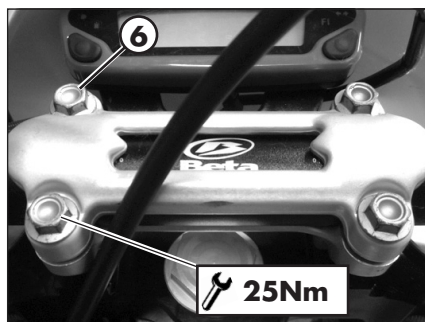

### ADJUSTMENT OF THE HANDLEBAR POSITION

The handlebar can be adjusted by rotating it back and forth.

To adjust the handlebar loosen screws **1**.

Position the handlebar according to requirements.

Tighten to the torque indicated.

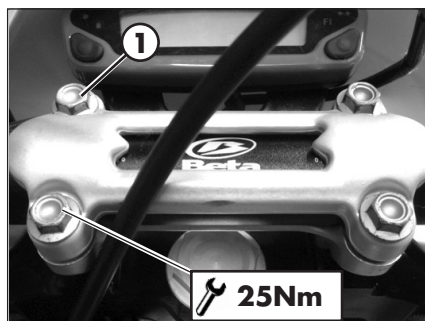

### ADJUSTING FORK

#### ADJUSTING THE REBOUND DAMPER

The hydraulic rebound damper determines the behaviour of the telescopic fork during extension and can be adjusted by means of screw **A**. Turning the screw clockwise increases the action of the rebound damper; turning it anticlockwise decreases the action of the rebound damper.

For standard calibration, refer to page 16.

#### ADJUSTING THE SPRING PRELOAD

Spring preload is adjusted by means of screw **B**. Turning clockwise will increase the preload, while rotating counter-clockwise decreases the preload.

For standard setting, refer to page 11.

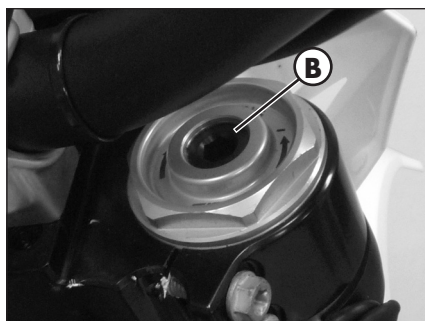
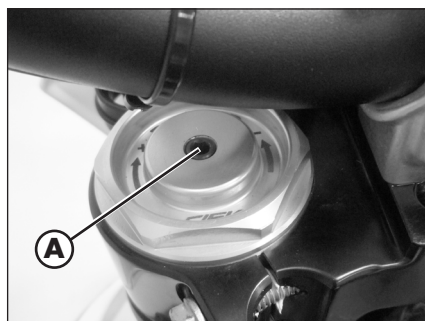

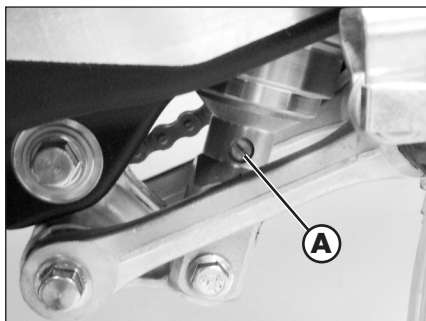

## SHOCK ABSORBER

### ADJUSTING THE REBOUND DAMPER

Turn screw **A** to adjust the hydraulic rebound damper.

Increase braking effect	Decrease braking effect

For adjustment refer to the table on the side.  
For standard setting, refer to page 11.

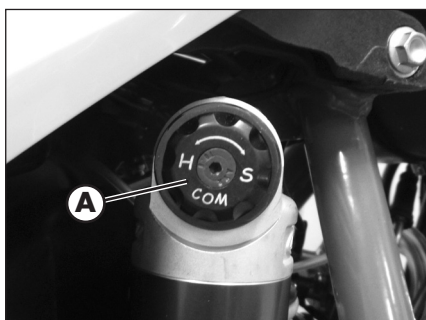

### ADJUSTING THE HYDRAULIC COMPRESSION DAMPER

Turn knob **A** to adjust the hydraulic compression damper.

Increase braking effect	Decrease braking effect

For adjustment refer to the table on the side.  
For standard setting, refer to page 11.



## ADJUSTING THE SPRING PRELOAD

To adjust the spring preload, use the procedure described below:

Loosen the locking dowel **A**.

Turn the ring nut **B** until you reach the desired preload.

Lock the locking dowel **A**.

For standard setting, refer to page 11.

Note: for movement of the rings use a specific sector key with square pin.

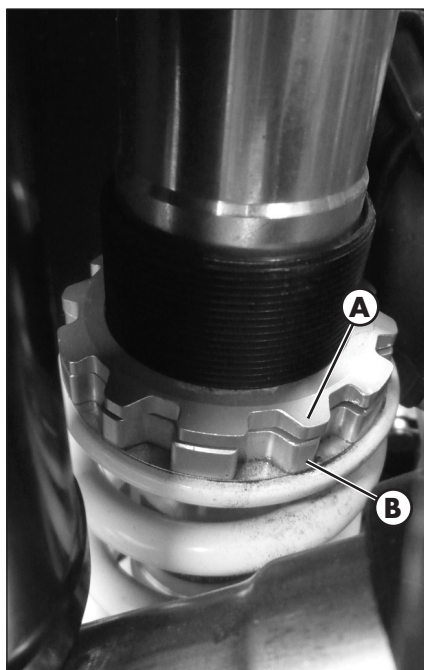

## STATIC SAG LOAD TEST

To verify the static sag of the shock absorber proceed as follows:

- Place the motorcycle on the work stand.
- Measure the vertical distance between the rear wheel axle and a reference point on the rear fairings.
- Write down the dimension  $H_1$ .
- Remove the work stand.
- Keep the motorcycle in vertical position and measure again the distance between the wheel axle and the reference point previously established.
- Write down the dimension  $H_2$ .

Verify that the value of the static compression  $X = H_1 - H_2$  matches the one shown on page 11. Otherwise, perform the adjustment of the spring preload as described above.

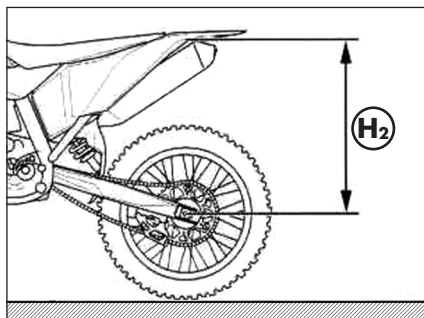
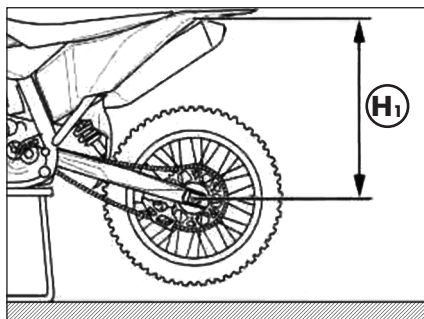



## CHAPTER 4 CHECKS AND MAINTENANCE

### CONTENTS

Key to symbols.....	44
Engine oil.....	44
Check the level .....	44
Replacement.....	44
Liquid coolant.....	45
Check the level .....	45
Replacement.....	46
Air filter cleaning.....	48
Air filter .....	48
Removing and installing air filter .....	48
Spark plug .....	49
Carburettor .....	50
Draining the carburettor float chamber.....	50
Checking the float level.....	51
Front brake.....	52
Check the level of the front brake fluid .....	52
Restoring the level of the front brake fluid .....	52
Bleeding the front brake.....	53
Front brake lining control .....	54
Brake disc thickness control .....	54
Rear brake .....	55
Check the level of the rear brake fluid.....	55
Restoring the level of the rear brake fluid.....	55
Bleeding the rear brake .....	56
Rear brake lining control.....	57
Brake disc thickness control .....	57
Clutch control .....	58
Check the level .....	58
Bleeding .....	59
Check and adjusting of steering play.....	60
Front wheel .....	61
Tightening .....	61
Fork.....	62
Rear suspension leverage.....	62
Tyres.....	63
Chain .....	63
Check and adjust tightening chain.....	63
Check for chain wear .....	64
Headlight.....	65
Replacing the headlight bulbs.....	65
Tail light.....	65
Battery.....	66
Battery removal and assembly .....	66
Inactivity .....	67
Charging the battery .....	67
Fuses .....	68
Cleaning the vehicle.....	69
General precautions .....	69
Prolonged inactivity.....	70
Scheduled maintenance vehicle .....	71
Tightening torque overview .....	73

## KEY TO SYMBOLS



Tightening torque



Threadlocker Medium

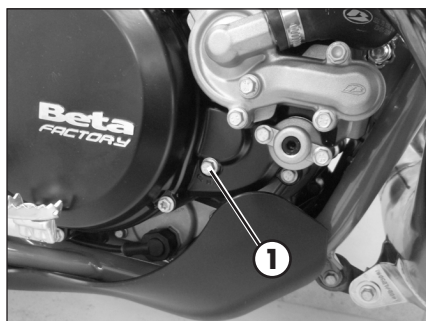

## ENGINE OIL

### CHECK THE LEVEL

Hold the vehicle upright.  
Position the drive on a flat base ensuring stability.

Remove the inspection cap **1**.

The oil level must arrive to the lower edge of check hole.

Otherwise restore the oil level through plug **2**.

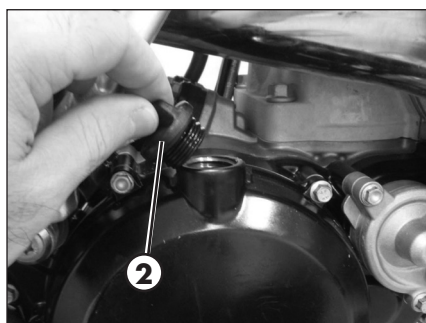

Use the oil indicated on page 16 in the "Recommended lubricants and liquids" table.

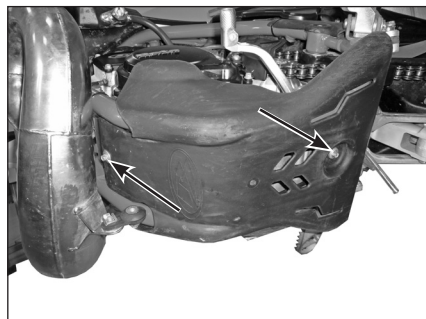

### REPLACEMENT

Always perform the replacement when engine is hot:

- Position the drive on a flat base ensuring stability.
- Remove the engine casing by loosening the screws shown in the figure.
- Place a container under the engine.



**WARNING:**

Hot oil can cause severe burns!

- Unscrew filler plug **1** and drain plug **2**.
- Drain all the oil from the crankcase.
- Place the cap **2** and tighten to specified torque.

Pour in the quantity of liquid indicated on page 10.

Use the oil indicated on page 16 in the "Recommended lubricants and liquids" table.

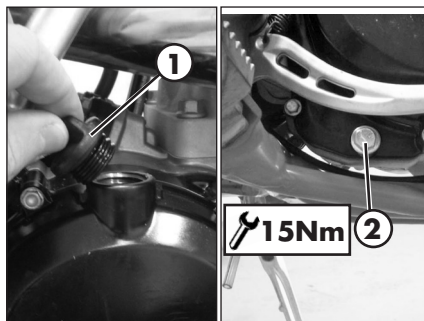

Screw on filler cap **1** again.

**WARNING:**

Dispose of used oil in compliance with the regulations in force.

## LIQUID COOLANT

### CHECK THE LEVEL

Keep the vehicle in vertical position relative to the ground.

The level of the coolant must be checked when the engine is cold. Use the following procedure:

- Unscrew cap **1** and ensure that the liquid is visible in the lower portion of the loading tube.
- In the case in which the liquid is not visible remove the vent screw **2** and proceed topping up.
- At the end of operation refit the filler cap and the vent screw.

Use the oil indicated on page 16 in the "Recommended lubricants and liquids" table.

- WARNING:**
-  Never unscrew the filler cap of the radiator when the engine is hot. Danger of burning!

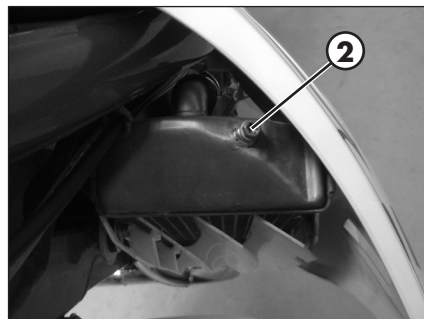
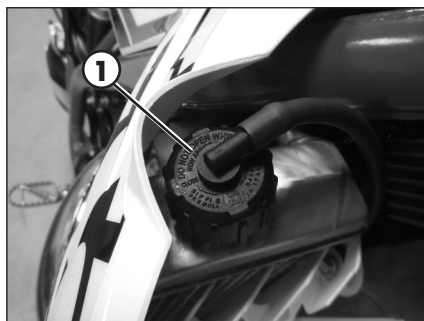

**WARNING:**

Wear appropriate protective clothing and protection gloves.



Keep coolant out of reach of children.



Avoid any direct contact of the coolant with skin, eyes or clothing. If this happens:

- with the eyes, rinse immediately with plenty of water and seek medical advice;
- with skin, Immediately clean contaminated areas with soap and water Change clothing that is contaminated with coolant.

If coolant is swallowed, contact a doctor immediately.

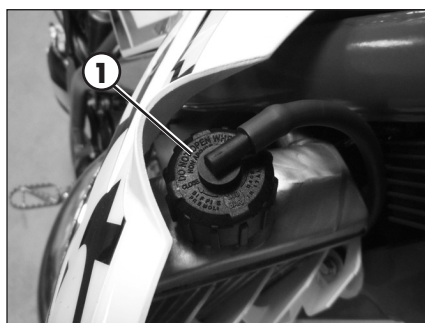
**REPLACEMENT**

Keep the vehicle in vertical position relative to the ground.

Replacement of the coolant must take place when the engine is cold.

- Unscrew cap **1**.
- Place a container under screw **2**.
- Unscrew the screw **2**.
- Drain the liquid.
- Tighten screw **2** applying the specific washer.



- Unscrew drain screw **3**.
- Proceed to filling.
- Reapply the loading cap and the bleeding screw.

The amounts of liquid are shown on page 10.

Use the liquid indicated on page 16 in the "Recommended lubricants and liquids" table.

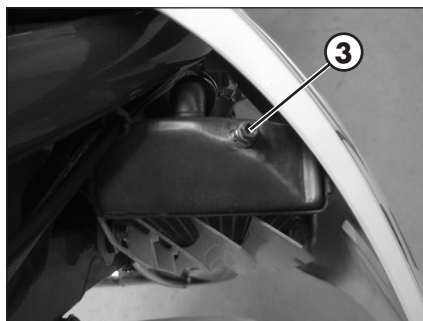

 **WARNING:**  
Never unscrew the filler cap of the radiator when the engine is hot.  
Danger of burning!

**WARNING:**  
Dispose of used liquid in compliance with the regulations in force.

 **WARNING:**  
Wear appropriate protective clothing and protection gloves.

 Keep coolant out of reach of children.

 Avoid any direct contact of the coolant with skin, eyes or clothing. If this happens:

- with the eyes, rinse immediately with plenty of water and seek medical advice;
- with skin, Immediately clean contaminated areas with soap and water Change clothing that is contaminated with coolant.

If coolant is swallowed, contact a doctor immediately.



## AIR FILTER

Check after every ride.

### REMOVING AND INSTALLING AIR FILTER

To access the filter is necessary:

- Remove the saddle (page 76).
- Pull the cover air filter (page 77).

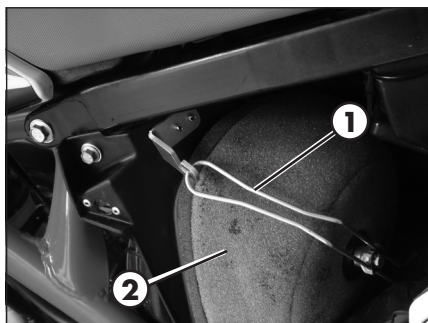

- Release filter fastener **1**.



- Pull out air filter **2**.

 **WARNING:**  
After every intervention, check that nothing has been left inside the filter box.

Reassemble by performing the operations in reverse order.

### AIR FILTER CLEANING

- Thoroughly wash the filter with water and soap.
- Dry the filter.
- Wet the filter with filter oil and then remove the excess oil to prevent it from dripping.
- If necessary also clean the interior of the filter box.

 **WARNING:**  
Do not clean the filter with gasoline or petrol.



 **NOTE:**  
If the filter is damaged, replace it immediately.  
To replace, contact authorised Betamotor customer service.

 **WARNING:**  
Never use the vehicle if the air filter is not in place. The infiltration of dust and dirt can cause damage and considerable wear.

 **WARNING:**  
After every intervention, check that nothing has been left inside the filter box.

## SPARK PLUG

Keeping the spark plug in good condition will reduce fuel consumption and increase engine performance.

To perform the check, just extract the spark plug cap and unscrew the spark plug by means of the provided wrench.

Carefully clean the electrodes using a wire brush. Blow the spark plug with compressed air to prevent any residues from getting into the engine.

Examine the distance between the electrodes with a feeler. This distance should be from 0,7 - 0,8 mm. If it is not, it may be corrected by bending the earth electrode.

The spark plug may appear:

black  "fat" carburation

light brown  appropriate carburation

white  "thin" carburation

Check as well that there are no cracks in the insulation or corroded electrodes. If so, replace immediately.

Lubricate the spark plug thread, and then (when the engine is cold) screw in the spark plug by hand to its abutting end. Finally tighten the spark plug with the spanner.

**NOTE:**

It is recommended to always use the spark plugs listed on page 12.

 **WARNING:**  
Do not check while the engine is hot.

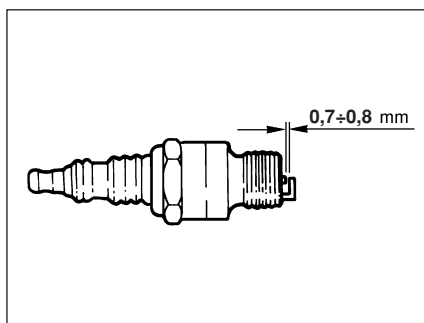

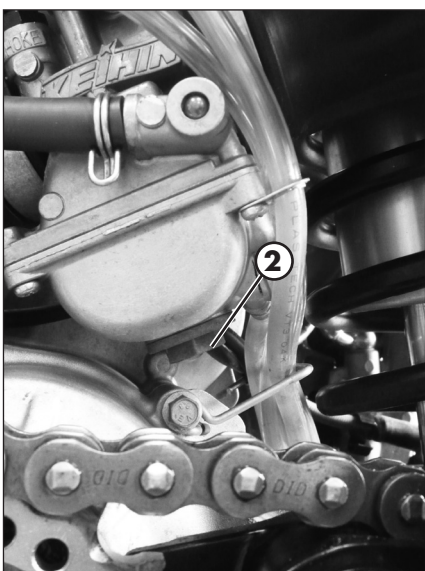
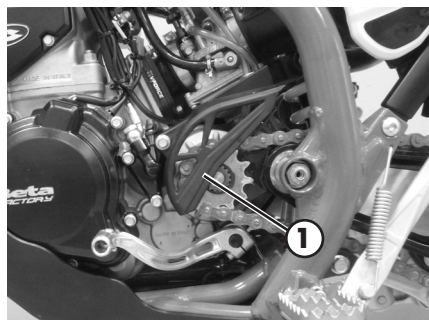

## CARBURETTOR

### DRAINING THE CARBURETTOR FLOAT CHAMBER

If the carburettor tank needs to be emptied, proceed as described.

Remove the chain protection **1**, close the tank tap and put a cloth under the carburettor, so that you can collect the running out fuel.

Open the drain screw **2** to drain the fuel. Close the drain screw.

Apply the chain protection and tighten the screws at 10Nm.



**WARNING:**

Follow action on a cold engine.



**WARNING:**

Fire hazard. Fuel is highly flammable.



Always stop the engine when refuelling and keep open flames and lighted cigarettes away.

Refuel in an open well ventilated area.



Immediately clean up any spilled fuel.

**WARNING:**

Risk of poisoning!

Fuel is poisonous liquid and a health hazard.



Wear appropriate protective clothing and protection gloves.

Fuel must not come into contact with the skin, eyes, and clothing. Do not breathe in the fuel vapours. If contact occurs with the eyes, rinse immediately with plenty of water and seek medical advice. If contact occurs with skin, immediately clean contaminated areas with soap and water. If fuel is swallowed, contact a doctor immediately. Change clothing that is contaminated with fuel.

**WARNING:**

Environmental pollution hazard!

The fuel must not contaminate the ground water, the ground, or the sewage system.

**CHECKING THE FLOAT LEVEL**

Remove the carburettor from the vehicle after following the procedure for emptying the carburettor bowl (page 69).

Remove the float chamber.

Keep the carburettor on a 60° approx. inclined, so that float leans on the needle valve without pressing it.

In this position the float edge should be parallel with the float chamber sealing surface (see figure).

If the float height does not correspond to the nominal value, check the float needle valve and if necessary replace it.

If the needle valve is in working order, adjust the float height by bending float lever **1**. Assemble the carburettor tank, assemble the carburettor and check idling.

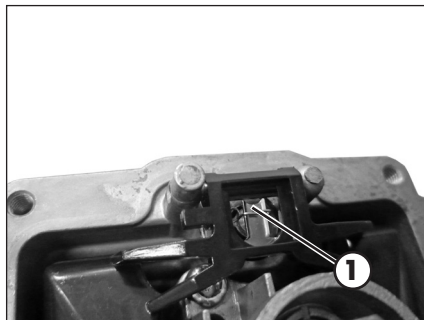
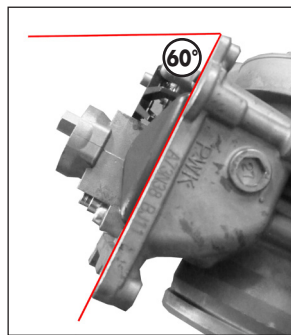

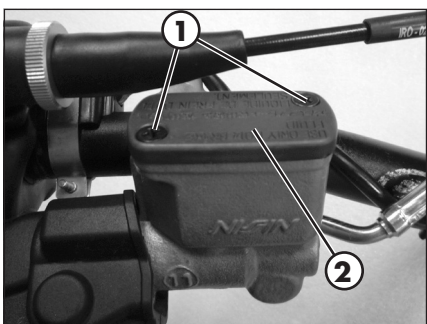
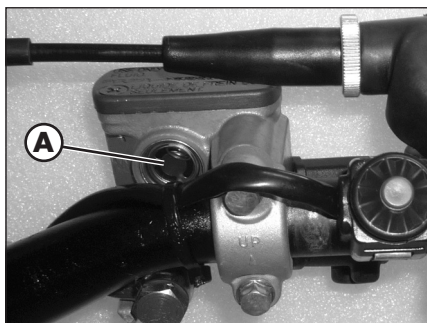

## FRONT BRAKE

### CHECK THE LEVEL OF THE FRONT BRAKE FLUID

Check the level of the brake fluid through sight **A**. The level of the fluid should never fall below the mark in the sight.

### RESTORING THE LEVEL OF THE FRONT BRAKE FLUID

To restore the level of the brake fluid, loosen the two screws **1**, lift cap **2** and add brake fluid until its level is 5 mm below the upper rim of the reservoir.

Use the liquid indicated on page 16 in the "Recommended lubricants and liquids" table.



#### WARNING:

The clutch fluid is extremely corrosive. Take care not to spill it on the paintwork.



Wear appropriate protective clothing and protection gloves.



Keep coolant out of reach of children.



**WARNING:** Avoid any direct contact of the liquid with skin, eyes or clothing. If this happens:

- with the eyes, rinse immediately with plenty of water and seek medical advice.
- with skin, immediately clean contaminated areas with soap and water. Change clothing that is contaminated with liquid.

If liquid is swallowed, contact a doctor immediately.

## BLEEDING THE FRONT BRAKE

To bleed air from the front brake circuit, proceed as follows:

- Remove the rubber cap **1** from the valve **2**.
- Open the sump cap.
- Place one end of a small transparent tube into the valve **2**, and the other end inside a container.
- Pump with the brake lever 2/3 times and keep the lever pressed.
- Unscrew the valve and let the oil drain.
- If air is still visible in the tube repeat above operation until obtaining a continuous outflow of oil without air bubbles.
- Close the valve and release the lever.

### NOTE:

During this procedure, continuously top up the brake pump tank to replace the oil that is out flowing.

- Remove the tube.
- Replace the rubber cap.
- Close the oil reservoir cap.

Use the liquid indicated on page 16 in the "Recommended lubricants and liquids" table.

 **WARNING:** The brake fluid is extremely corrosive. Take care not to spill it on the paintwork.

 Wear appropriate protective clothing and protection gloves.

 Keep coolant out of reach of children.

 **WARNING:** Avoid any direct contact of the liquid with skin, eyes or clothing. If this happens:

- with the eyes, rinse immediately with plenty of water and seek medical advice.
- with skin, immediately clean contaminated areas with soap and water. Change clothing that is contaminated with liquid.

If liquid is swallowed, contact a doctor immediately.



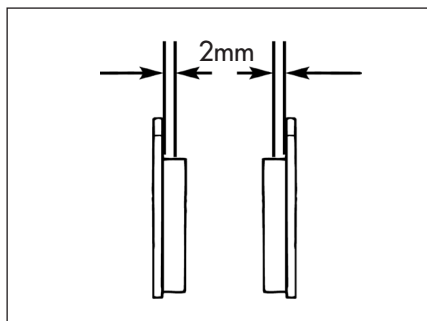

## FRONT BRAKE LINING CONTROL

In order to verify the wear condition of front brake is enough to view the caliper from the bottom, where is possible to glimpse the brake lining tails which will have to show a brake of 2 mm in thickness. If the stratum is lesser let's start replacing them.

Note:

Perform the check according to the times shown in the table on page 71.

To replace, contact authorised Betamotor customer service.

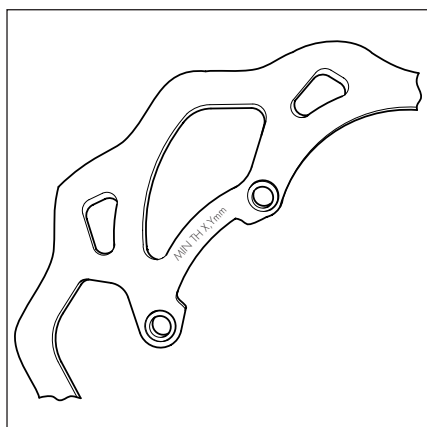

## BRAKE DISC THICKNESS CONTROL

Periodically verify disc condition. In case signs of damage, veins, or deformations are present, proceed with replacement. Verify disc thickness. The minimum thickness is engraved on the disc.

Once the limit is in proximity or has been reached, proceed with brake disc replacement.

For replacement, contact an authorised Betamotor after-sales service centre.

## REAR BRAKE

### CHECK THE LEVEL OF THE REAR BRAKE FLUID

Check the level of the brake fluid through sight **A**. The level of the fluid should never fall below the mark in the sight.

### RESTORING THE LEVEL OF THE REAR BRAKE FLUID

To restore the oil level, top up by means of oil filler cap **1**.

Use the liquid indicated on page 16 in the "Recommended lubricants and liquids" table.

 **WARNING:**  
The brake fluid is extremely corrosive. Take care not to spill it on the paintwork.

 Wear appropriate protective clothing and protection gloves.

 Keep coolant out of reach of children.

 **WARNING:** Avoid any direct contact of the liquid with skin, eyes or clothing. If this happens:

- with the eyes, rinse immediately with plenty of water and seek medical advice.
- with skin, immediately clean contaminated areas with soap and water. Change clothing that is contaminated with liquid.

If liquid is swallowed, contact a doctor immediately.

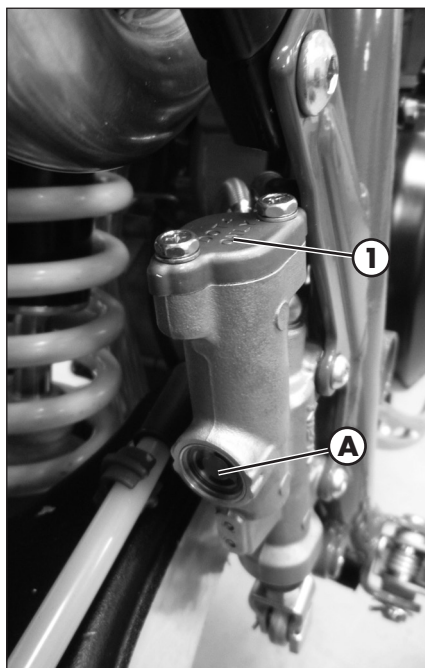

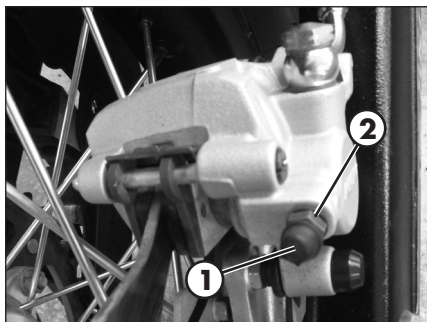

## BLEEDING THE REAR BRAKE

To bleed air from the rear brake circuit, proceed as follows:

- Remove the rubber cap **1** from the valve **2**.
- Open the sump cap.
- Place one end of a small transparent tube into the valve **2**, and the other end inside a container.
- Pump with the brake lever 2/3 times and keep the pedal pressed.
- Unscrew the valve and let the oil drain.
- If air is still visible in the tube repeat above operation until obtaining a continuous outflow of oil within no air bubbles.
- Close the valve and release the lever.

### NOTE:

During this procedure, continuously top up the brake pump tank to replace the oil that is out flowing.

- Remove the tube.
- Replace the rubber cap.
- Close the oil reservoir cap.

Use the liquid indicated on page 16 in the "Recommended lubricants and liquids" table.



### WARNING:

The brake fluid is extremely corrosive. Take care not to spill it on the paintwork.



Wear appropriate protective clothing and protection gloves.



Keep coolant out of reach of children.



**WARNING:** Avoid any direct contact of the liquid with skin, eyes or clothing.  
If this happens:

- with the eyes, rinse immediately with plenty of water and seek medical advice.
- with skin, immediately clean contaminated areas with soap and water. Change clothing that is contaminated with liquid.

If liquid is swallowed, contact a doctor immediately.



## REAR BRAKE LINING CONTROL

In order to verify the wear condition of rear brake is enough to view the caliper from above, where is possible to glimpse the brake lining tails which will have to show a brake of 2 mm in thickness. If the stratum is lesser let's start replacing them.

Note:

Perform the check according to the times shown in the table on page 71.

To replace, contact authorised Betamotor customer service.

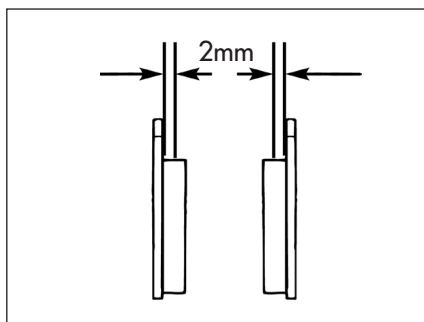

## BRAKE DISC THICKNESS CONTROL

Periodically verify disc condition. In case signs of damage, veins, or deformations are present, proceed with replacement. Verify disc thickness. The minimum thickness is engraved on the disc.

Once the limit is in proximity or has been reached, proceed with brake disc replacement.

For replacement, contact an authorised Betamotor after-sales service centre.

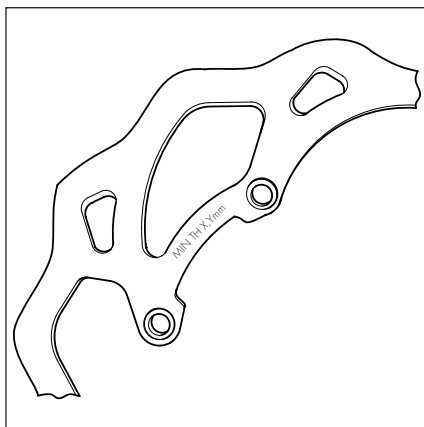

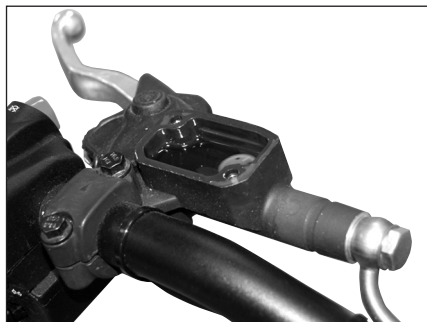
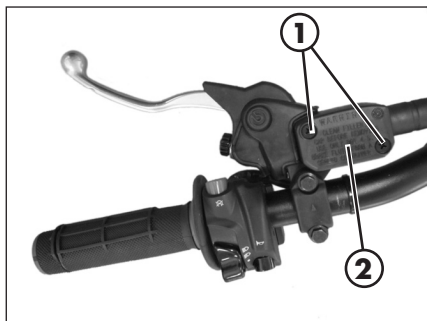

## CLUTCH CONTROL

### CHECK THE LEVEL

To check the oil level in the clutch pump, first remove cover **2**.

Remove the two screws **1** and take off cover **1** together with the rubber bellows. With the clutch pump in a horizontal position, the level of the oil should be 5 mm below the upper rim.

In the case where the level is lower than specified top up.

Use the liquid indicated on page 16 in the "Recommended lubricants and liquids" table.



**WARNING:**

The clutch fluid is extremely corrosive. Take care not to spill it on the paintwork.



Wear appropriate protective clothing and protection gloves.



Keep coolant out of reach of children



**WARNING:** Avoid any direct contact of the liquid with skin, eyes or clothing. If this happens:

- with the eyes, rinse immediately with plenty of water and seek medical advice.
- with skin, immediately clean contaminated areas with soap and water. Change clothing that is contaminated with liquid.

If liquid is swallowed, contact a doctor immediately.

## BLEEDING

To bleed air from the clutch pump, proceed as follows:

- Remove the rubber cap **1** from the valve **2**.
- Open the sump cap.
- Place one end of a small transparent tube into the valve **2**, and the other end inside a container.
- Pump with the clutch lever 2/3 times and keep the lever pressed.
- Unscrew the valve and let the oil drain.
- If air is still visible in the tube repeat above operation until obtaining a continuous outflow of oil within no air bubbles.
- Close the valve and release the lever.

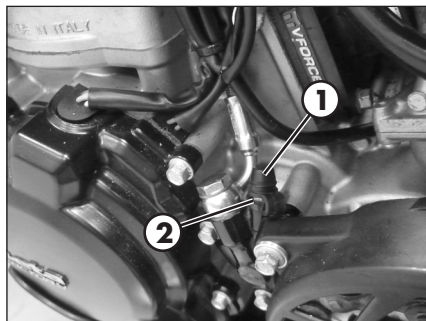

### NOTE:

During this procedure, continuously top up the pump tank to replace the liquid that is out flowing.

- Remove the tube.
- Replace the rubber cap.

Use the liquid indicated on page 16 in the "Recommended lubricants and liquids" table.



### WARNING:

The clutch fluid is extremely corrosive. Take care not to spill it on the paintwork.



Wear appropriate protective clothing and protection gloves.



Keep coolant out of reach of children.



**WARNING:** Avoid any direct contact of the liquid with skin, eyes or clothing. If this happens:

- with the eyes, rinse immediately with plenty of water and seek medical advice.
- with skin, immediately clean contaminated areas with soap and water. Change clothing that is contaminated with liquid.

If liquid is swallowed, contact a doctor immediately.

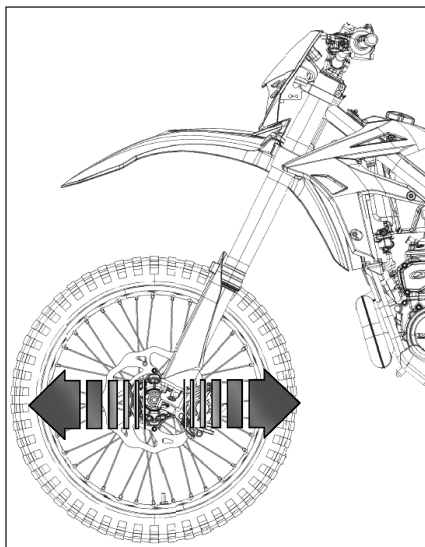

## CHECK AND ADJUSTING OF STEERING PLAY

Periodically check the play in the steering sleeve by moving the fork back and forth as shown in the figure. Whenever you feel play, adjust as described below:

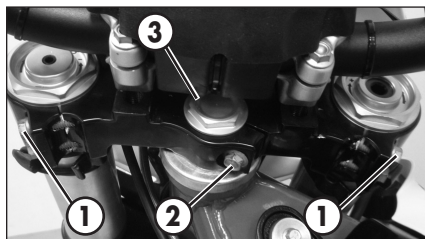

- Loosen the screws **1**
- Loosen the screw **2**
- Reduce the play by turning nut **3**

Tighten the screws to the prescribed torque values.

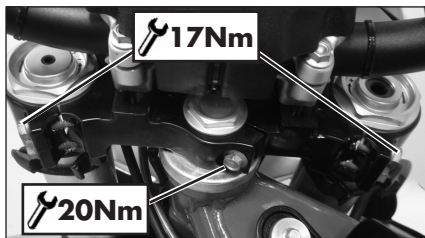

## FRONT WHEEL

### TIGHTENING

Following removal of the wheel:

- Compress and release the fork 3-4 times.

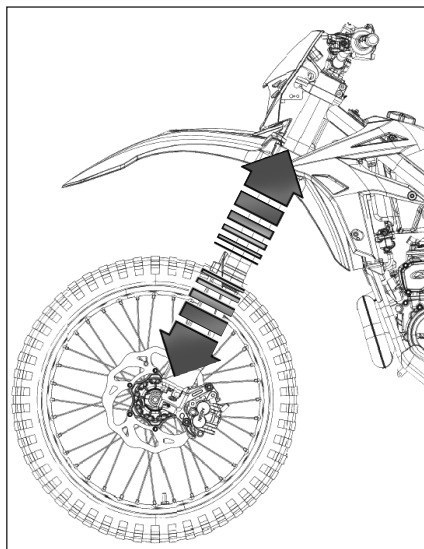

- Tighten the wheel bolt and the screws of the footleg.

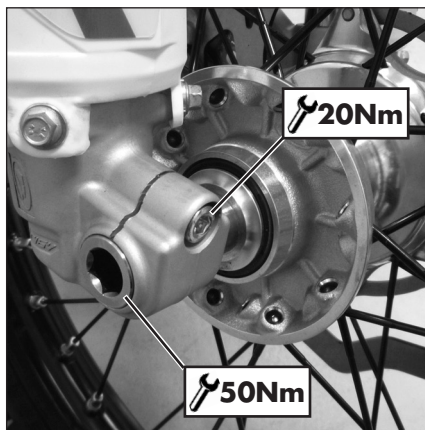



## FORK

To maintenance refer at an authorized service center Betamotor.

To check the tightening torques see as shown in the figure.

### WARNING:

Tightening of the screws should be carried out by adjusting the torque wrench to the stability torque with repeated tightening until stability torque has been achieved.

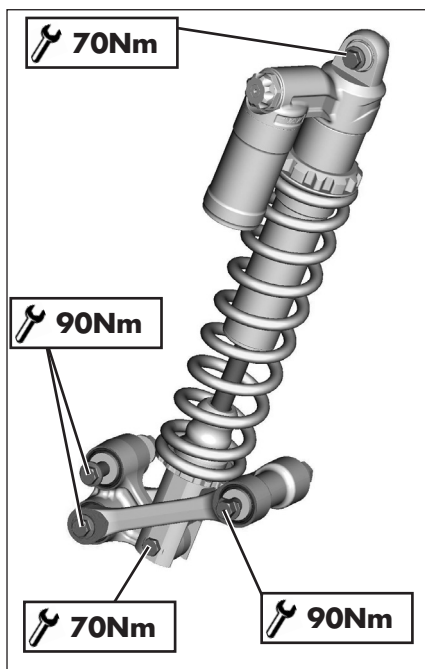

## REAR SUSPENSION LEVERAGE

In order to guarantee optimal operation and duration over time of the progressive leverage of the rear suspension, it is recommended to periodically check correct tightness of nuts and bolts.

Verify that suspension nuts and bolts are at the indicated torque.

## TYRES

Only fit tyres approved by BETAMOTOR.

Unsuitable tyres can adversely affect the road holding of the vehicle.

- To protect your safety, immediately replace any damaged tyres.
- Slick tyres adversely affect the road holding of the vehicle, especially on wet roads and in off-road riding.
- Insufficient pressure results in abnormal wear and overheating of the tyres.
- The front and rear tyres must have the same tread design.
- Always measure the inflating pressures when the tyres are cold.
- Keep the tyre pressures within the prescribed range.

## CHAIN

Checking the drive chain periodically to ensure longer chain life. Always keep it lubricated and clean of deposited dirt.

Take special care in preventing the lubricant from coming into contact with the rear tyre or brake disc, otherwise the tyre grip and the action of the brake would be greatly reduced, making it very difficult to control the vehicle.

### CHECK AND ADJUST TIGHTENING CHAIN

Position the drive on a flat base ensuring stability.

If the chain play exceeds 20 mm tension the chain.

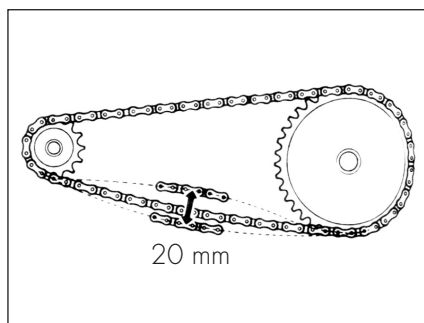

- Loosen the pin **1**.

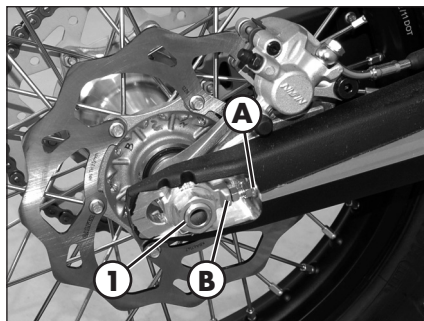

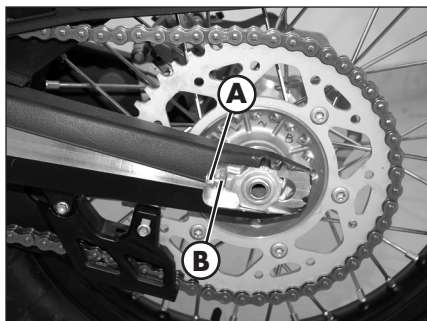

- Loosen counternuts **A** on either side of the fork.
- Turn adjusting screws **B** on either side until the desired chain tension is obtained.
- Tighten counternuts **A** on either side of the fork.

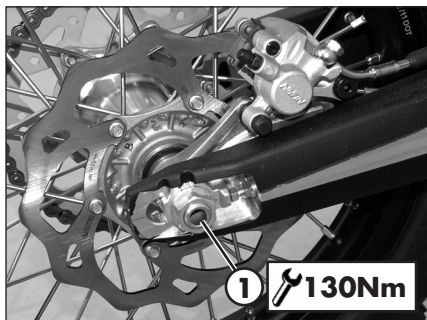

- Tighten the pin **1** to the torque indicated.

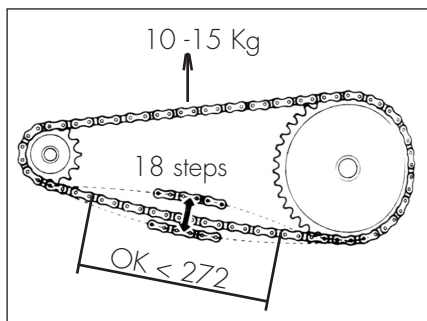

### CHECK FOR CHAIN WEAR

Shift into neutral, pull up the upper stretch of the chain with a force of 10 - 15 kg (see figure). Measure the length of 18 links on the lower stretch of the chain. If the length is  $\geq 272$  mm, replace the chain. Chains do not always wear evenly. For this reason it is important that the measurement is taken at different points along the chain.

When fitting a new chain, be sure to replace the chainring and sprocket as well. New chains wear more quickly if fitted on old and worn sprockets. After replacing the chain, adjust its tension as described on page 63.



## HEADLIGHT

Keep the headlight glass clean at all times (see page 69).

Periodically check the correct angle of the light beam.

## REPLACING THE HEADLIGHT BULBS

Remove the fixing screws and move forward the lamp holder front cowl.

Carefully remove the headlight bulb **1** together with lamp holder. To replace the high beam/low beam, lift the rubber cover **2**, release connector, push on the spring **3** and remove the lamp holder and replace the light bulb with a new one. Be careful not to touch the bulb so as not to compromise its efficiency.

To refit, follow the procedure above but in reverse order.

Fasten the lamp holder front cowl to the supporting pins and fix it with the two elastics.

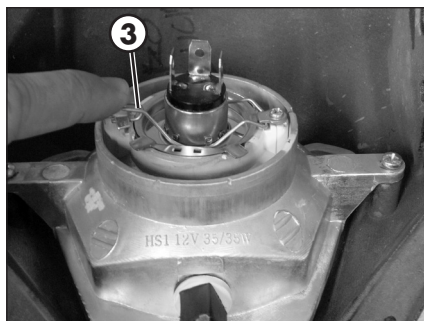
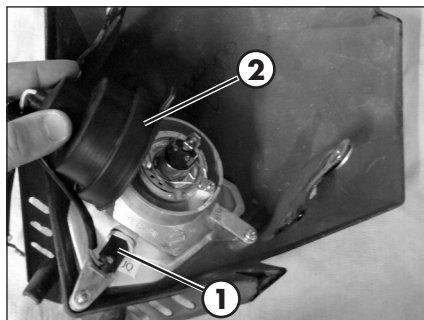

## TAIL LIGHT

Keep the tail light glass clean at all times (see page 69).

The LED tail light is sealed. In the case of burnout of one or more LEDs it is necessary to replace the entire group.

To replace, contact authorised Betamotor customer service.



## BATTERY

Battery is located under the saddle and requires no maintenance.

Keep the battery terminals clean. If necessary, protect them with a thin film of acid-free grease.

## BATTERY REMOVAL AND ASSEMBLY

Remove the saddle (page 76).

Release the rubber band.

FIRST disconnect the negative connector (black) from negative (-) pole and THEN positive connector (black) from negative (+) pole.

Remove the battery.

When fitting the battery, insert it with the terminals as shown in picture.

FIRST connect the positive connector (red) from positive (+) pole and then negative connector (black) from negative (-) pole.

Reattach the rubber band.

### WARNING:

Exercise extreme caution if, for any reason, the electrolyte (sulphuric acid) should come out of the battery. The electrolyte can cause serious burns. In case of contact with the skin, rinse abundantly with water.

Should the electrolyte come into contact with the eyes, rinse with water for at least 15 minutes and immediately seek medical attention.

Even though the battery is sealed, there is a possibility that explosive gases may leak out.

Keep sparks and open flames away from the battery.

Keep spent batteries out of the reach of children and dispose of them as prescribed by law.

Do not remove the protections.

When installing the battery, be sure to observe the polarity of the terminals.

## INACTIVITY

If the vehicle is not going to be used for a long time, remove the battery and charge it every 15 days using a suitable charger.

Store the battery in a dry place at a temperature of 5 to 35°C and out of the reach of children.

## CHARGING THE BATTERY

Using an open-circuit multimeter (10-12 hours after the activation), check that the voltage is greater than 12.6 V. If it is lower, it is advisable to recharge the battery.

Based on the type of charger available, charge the battery using either of the following procedures:

- Constant voltage (14.4÷15 V) - Charge the battery for about 12 hours. Check the voltage 10÷12 hours after the end of recharge as described above.
- Constant current: Charge battery at 0.5/0.8 A until the voltage between the terminals stabilizes at ~14.5 V.

### WARNING:

The battery is sealed. When recharging it, do not remove the seal nor add any liquid.





## FUSES

To access the fuse, remove the saddle (page 76).

In the case of blown fuse, the vehicle will not start/stop:



Three spare fuses comes with the kit accompanying the vehicle.

A blown fuse should only be replaced with another of the same type.

Should the new fuse also burn out when fitted, immediately contact a specialized BETAMOTOR dealer.

## CLEANING THE VEHICLE

### GENERAL PRECAUTIONS

-  **WARNING:** Do not clean your vehicle with a high-pressure device with a strong jet of water. Excessive pressure can reach electrical components, connectors, flexible cables, bearings, etc and can damage or destroy them.
-  **WARNING:** Wash motorbikes frequently with cold water that are used near the sea (salty air) and on roads subject to salt spreading in winter. Cover with a film of oil or silicone spray unpainted parts and the most exposed parts such as wheels, forks and swingarm. Do not treat rubber parts and brakes.

When cleaning, avoid direct exposure to sunlight.

Close off the exhaust system to prevent water from entering.

-  Avoid directing the jet of water onto the air filter box cover and the throttle body.

### WASHING MODE



Use water jet to soften the dirt and mud accumulated on the paintwork, then remove them with a soft bodywork sponge soaked in water and shampoo. Subsequently rinse well with water, and dry with air and cloth or suede leather.

Detergents pollute water. Always wash the vehicle in areas equipped for collection and purification of the washing liquids.

### AFTER WASHING

Proceed to the emptying of the filter box using the appropriate ventilation and drying.

After cleaning, ride a short distance until the engine reaches operating temperature.

-   **WARNING:** braking effect is reduced with wet brakes. Operate the brakes cautiously to allow them to dry.

Push back the handlebar control covers, so that water can evaporate.

When the bike is completely dry and cooled down, lubricate all moving parts.

Treat all plastic and painted components with non-aggressive detergents or products that are specific for the care of the motorcycle.

## 4 PROLONGED INACTIVITY

A few simple operations should be performed to keep the vehicle in good condition whenever it is to remain inactive for a long period (e.g. during the winter):

- Thoroughly clean the vehicle.
- Reduce the tyre pressures by approximately 30 percent, and if possible raise the tyres off the ground.
- Cover the unpainted parts, excepting the brakes and the rubber parts, with a film of oil or spray silicone.
- Remove the battery and keep it in a dry place. Charge the battery every 15 days.
- Protect the vehicle with a dust cover.

### AFTER PROLONGED INACTIVITY

- Reinstall the battery.
- Restore the tyre inflating pressures.
- Check the tightening of all the screws having an important mechanical function.

## SCHEDULED MAINTENANCE VEHICLE

		End of running-in - 3 hours	Coupon 1 - 30 hours	Coupon 2 - 60 hours	Coupon 3 - 90 hours	Coupon 4 - 120 hours	Coupon 5 - 150 hours	Coupon 6 - 180 hours
<b>Engine</b>	Gear and clutch oil	S	S	S	S	S	S	S
	Spark plug	C		S		S		S
	Head screws	T						
	Engine clamping screws *	C	C	C	C	C	C	C
	Kick start and gearchange lever screws	C	C	C	C	C	C	C
	Spark plug cap	P	P	P	P	P	P	P
	Coated clutch disks		C	C	S	C	C	S
	Clutch springs length		C	C	S	C	C	S
	Clutch/bell hub		C	C	C	C	C	C
	Gearbox bearing (drive shaft side)				S			S
	Cylinder			C		C		C
	Piston and segments			S		S		S
	Connecting rod				S			S
	Drive shaft bearings				S			S
	Surface appearance of the gearbox				C			C
	Water pump oil seal				S			S
	Exhaust valve			C/P			C/P	
Reed valve			C		C		C	
<b>Carburetor</b>	Tightness	C	C	C	C	C	C	C
	Idling setting	C	C	C	C	C	C	C
	Fuel pipe	C	C	C	C	C	C	C
	Breather pipe	C	C	C	C	C	C	C
<b>Assembling groups</b>	Coolant system tightness and coolant level	C	C	C	C	C	C	C
	Exhaust manifold tightness	C	C	C	C	C	C	C
	Drives sliding and regulation	C	C	C	C	C	C	C
	Liquid level clutch pump	C	C	C	C	C	C	C
	Airbox and air filter	P	P	P	P	P	P	P
	Chain, plate wheel and pinion	C	C	C	C	C	C	C

Key

**C Check** (Clean, adjust, lubricate, replace as necessary)**S Replace/renew****R Adjust****P Clean****T Tighten**

		End of running-in - 3 hours	Coupon 1 - 30 hours	Coupon 2 - 60 hours	Coupon 3 - 90 hours	Coupon 4 - 120 hours	Coupon 5 - 150 hours	Coupon 6 - 180 hours
<b>Brakes</b>	Liquid level, pads thickness	C	C	C	C	C	C	C
	Disc thickness	C	C	C	C	C	C	C
	Pipe tightness	C	C	C	C	C	C	C
	Idle travel levers and drives sliding	C	C	C	C	C	C	C
<b>Cycling</b>	Shock absorber and telescopic fork	C	C	C	C	C	C	C
	Fork cover	P	P	P	P	P	P	P
	Bearings of steering	C	C	C	C	C	C	C
	Bolts	T	T	T	T	T	T	T
<b>Wheels</b>	Wheel spokes and rim coaxiality	C	C	C	C	C	C	C
	Tyres (wear and pressure)	C	C	C	C	C	C	C
	Bearings clearance	C	C	C	C	C	C	C

Key

**C Check** (Clean, adjust, lubricate, replace as necessary)

**S Replace/renew**

**R Adjust**

**P Clean**

**T Tighten**

(*) Attachment	Screw	Thread locker	Torque [Nm]
Engine to chassis	Special screw M10		45
Brackets to attach the head to the chassis	M8x16	M*	35
Brackets to attach the head to the engine	M8x60		35

\* Medium resistance thread locker

WARNING:

For any service requirements, please contact Betamotor's Authorized Service Network.



## TIGHTENING TORQUE OVERVIEW

Here below is an overview of the tightening torque of all pieces subject to adjustment or maintenance:

<b>Forecarriage</b>		
	Tightening torque [Nm]	Threadlock
Wheel pin	50	
Fork foots - wheel pin	20	
Cavallotto parastelo sinistro	1,5	
Steering head base - fork legs	12*	
Steering head - fork legs	17*	
Stem pin on steering head	20	
Lower handlebar u-bolt - steering head	40	M
Upper handlebar u-bolt - lower handlebar u-bolt	25	

<b>Rear axle</b>		
	Tightening torque [Nm]	Threadlock
Wheel pin	130	
Rear shock absorber - frame	70	
Rear shock absorber - rocker arm	70	
Connecting rod - frame	90	
Connecting rod - rocker arm	90	
Rocker arm - swinging arm	90	

<b>Engine</b>		
	Tightening torque [Nm]	Threadlock
Gearbox oil drain plug	15	

<b>Engine - Frame</b>		
	Tightening torque [Nm]	Note
Pins motor - frame	45	
Brackets to attach the head - frame (front fixing)	35	M
Brackets to attach the head - frame (rear fixing)	35	M
Brackets to attach the head - motor	35	

M Medium strength threadlock



WARNING:

Tightening of the screws should be carried out by adjusting the torque wrench to the stability torque with repeated tightening until stability torque has been achieved.



**CHAPTER 5 REPLACEMENTS**

## CONTENTS

Removal and refitting of the saddle.....	76
Removing and installing air filter cover panel.....	77

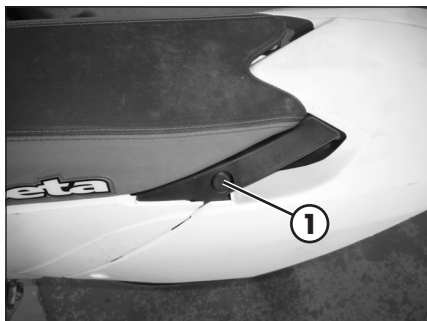

## REMOVAL AND REFITTING OF THE SADDLE

Press button **1**.

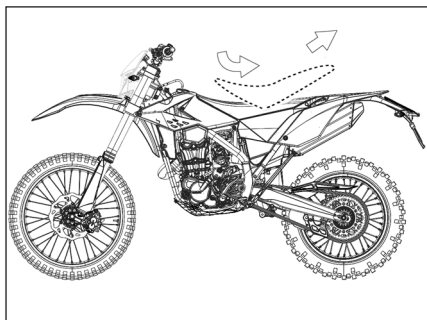

Remove the saddle towards the rear of the motorcycle.



To re-assemble insert the cavity **1** of the saddle in slot **2**.

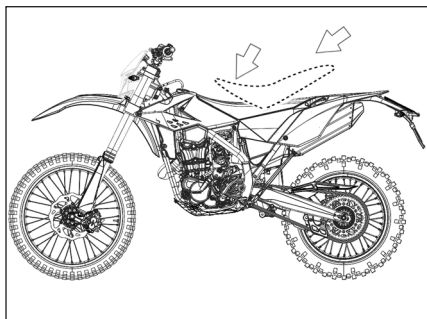

Press the saddle down in the middle and at the same time, push it forwards until the bayonet joint engages in its seat.

**WARNING**

Make sure the bayonet joint **3** is firmly inserted into the button lock.

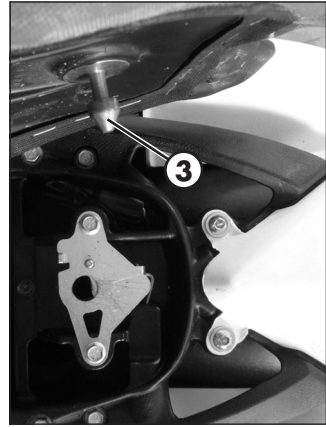
**REMOVING AND INSTALLING AIR FILTER COVER PANEL**

Remove the saddle (page 76).

Grab the side panel in the front side and pull out.

To refit insert the tabs **1** into their slots.

Slide the side panel toward the vehicle.





**CHAPTER 6 TROUBLESHOOTING**

## CONTENTS

Troubleshooting .....	80
Alphabetical index .....	81

# 6 TROUBLESHOOTING

## TROUBLESHOOTING

PROBLEM	CAUSE	REMEDY
Engine does not start	- Fuel system clogged (fuel lines, fuel tank, fuel cock)	Contact authorised BETAMOTOR customer service
	- Air filter dirty	Check the air filter
	- No current supplied to spark plug	Clean or replace the spark plug. If the problem persists, contact authorised BETAMOTOR customer service
	- Engine flooded	Operate the electrical starter push button 2 times for 5 seconds. If the vehicle does not start, remove and dry the spark plug
	- Excessive distance between the electrodes	Check the distance between the electrodes
	- Ignition connector or coil slackened or oxidized	Clean with a spray product for electric contacts and tighten
	- Presence of water in the carburettor	Empty the carburettor tank
"Mixer system" indicator lights up (Page 29)	- Detected possible problem with the electronic mixer system	Empty the fuel tank and refuel with mixture at 1.6%. Contact authorised BETAMOTOR customer service
Engine misfires	- Spark gap wrongly adjusted	Restore the spark gap
	- Spark plug dirty	Clean or replace the spark plug
The engine does not hold idling	- Idling air jet clogged	Contact authorised BETAMOTOR customer service
	- Adjustment screws poorly adjusted	Adjust
	- Faulty spark plug	Replace the spark plug
	- Faulty ignition system	Check the coil and the spark plug cap
Engine overheats and loses power	- Silencer partly clogged	Contact authorised BETAMOTOR customer service
	- Laminar pack damaged	Contact authorised BETAMOTOR customer service
	- Fault in the ignition system	Contact authorised BETAMOTOR customer service
Excessive smoke	- Possible mixer system fault	Contact authorised BETAMOTOR customer service
Front braking poor	- Brake pads worn	Contact authorised BETAMOTOR customer service
	- Air or humidity in the hydraulic circuit	Follow the procedure described on page 53
Rear braking poor	- Brake pads worn	Contact authorised BETAMOTOR customer service
	- Air or humidity in the hydraulic circuit	Follow the procedure described on page 56



## ALPHABETICAL INDEX

Adjusting fork.....	39
Adjusting the idle speed.....	35
Adjustment of gas clearance.....	35
Air filter .....	48
Battery.....	66
Brakes .....	34
Carburettor .....	50
Chain .....	63
Check and adjusting of steering play.....	60
Checks before and after use .....	29
Cleaning the vehicle.....	69
Clutch.....	34
Clutch control .....	58
Digital rpm indicator operating instructions.....	23
Electrical system.....	14
Engine oil.....	44
Engine shut-down.....	31
Exhaust valve control adjustment .....	38
Familiarizing with the vehicle.....	9
Fork.....	62
Front brake.....	52
Front wheel .....	61
Fuses .....	68
Handlebar adjustment .....	38
Headlight.....	65
Key to symbols.....	34
Key to symbols.....	44
Liquid coolant.....	45
Main parts .....	18

Oil mixer refuelling ..... 31

Operating instructions..... 5

Prolonged inactivity ..... 70

Rear brake ..... 55

Rear suspension leverage..... 62

Recommended lubricants and liquid ..... 16

Refuelling ..... 30

Removal and refitting of the saddle..... 76

Removing and installing air filter cover panel..... 77

Replacing the headlight bulbs..... 65

Riding safety ..... 6

Running in..... 29

Scheduled maintenance vehicle ..... 71

Shock absorber..... 40

Spark plug ..... 49

Specifications ..... 10

Starting the engine ..... 31

Symbols..... 5

Tail light..... 65

Tightening torque overview ..... 73

Tools kit ..... 8

Troubleshooting ..... 80

Tyres..... 63

Vehicle identification data ..... 8