



13/04/09 17:38:26 32KRHA21_001



Honda XR125LK/LEK XL125LK

OWNER'S MANUAL



© Honda Motor Co., Ltd. 2012

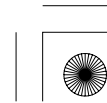
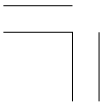



IMPORTANT INFORMATION

- **OPERATOR AND PASSENGER**

This motorcycle is designed to carry the operator and one passenger. Never exceed the maximum weight capacity.

- **ON/OFF-ROAD USE**

This motorcycle is designed for “dual purpose” use.

- **READ THIS OWNER’S MANUAL CAREFULLY**

Pay special attention to the safety messages that appear throughout the manual. These messages are fully explained in the “A Few Words About Safety” section which appears before the Contents page.

This manual should be considered a permanent part of the motorcycle and should remain with the motorcycle when resold.

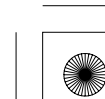
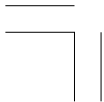



12/04/20 16:58:44 32KRHA20_003



**Honda XR125LK/LEK
XL125LK
OWNER'S MANUAL**

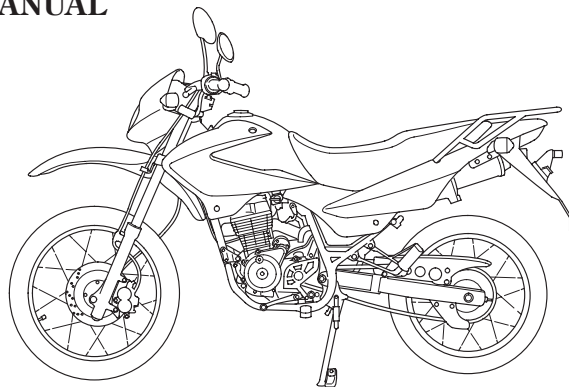

All information in this publication is based on the latest production information available at the time of approval for printing. Honda Motor Co.,Ltd. reserves the right to make changes at any time without notice and without incurring any obligation.

No part of this publication may be reproduced without written permission.

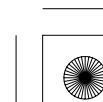
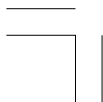



WELCOME

The motorcycle presents you a challenge to master the machine, a challenge to adventure. You ride through the wind, linked to the road by a vehicle that responds to your commands as no other does. Unlike an automobile, there is no metal cage around you. Like an airplane, a pre-ride inspection and regular maintenance are essential to your safety. Your reward is freedom.

To meet the challenges safely, and to enjoy the adventure fully, you should become thoroughly familiar with this owner's manual **BEFORE YOU RIDE THE MOTORCYCLE**.

As you read this manual, you will find information that is preceded by a **NOTICE** symbol. This information is intended to help you avoid damage to your motorcycle, other property, or the environment.

Pleasant riding, and thank you for choosing a Honda !

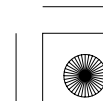
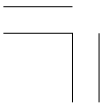



- The following codes in this manual indicate each country.

XR125LK

DK	General export (km/h)
III LA	Latin America (Type III)

XR125LEK

DK	General export (km/h)
III LA	Latin America (Type III)
CO	Colombia
NZ	New Zealand
	Ukraine
ILA	Latin America (Type I)
PH	Philippines

XL125LK

IIDK	General export (km/h) (Type II)
------	---------------------------------

- The specifications may vary with each locale.
- The illustrations herein are based on the XR125LEK ILA type.
- This vehicle pictured in this owner's manual may not match your actual vehicle.

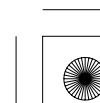
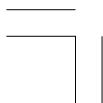



A FEW WORDS ABOUT SAFETY

Your safety, and the safety of others, is very important. And operating this motorcycle safely is an important responsibility.

To help you make informed decisions about safety, we have provided operating procedures and other information on labels and in this manual. This information alerts you to potential hazards that could hurt you or others.

Of course, it is not practical or possible to warn you about all hazards associated with operating or maintaining a motorcycle. You must use your own good judgment.

You will find important safety information in a variety of forms, including:

- **Safety Labels** — on the motorcycle.
- **Safety Messages** — preceded by a safety alert symbol  and one of three signal words: **DANGER**, **WARNING**, or **CAUTION**.

These signal words mean:

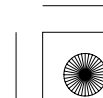



⚠ DANGER

You WILL be KILLED or SERIOUSLY HURT if you don't follow instructions.

⚠ WARNING

You CAN be KILLED or SERIOUSLY HURT if you don't follow instructions.

⚠ CAUTION

You CAN be HURT if you don't follow instructions.

- **Safety Headings** — such as Important Safety Reminders or Important Safety Precautions.
- **Safety Section** — such as Motorcycle Safety.
- **Instructions** — how to use this motorcycle correctly and safely.

This entire manual is filled with important safety information — please read it carefully.

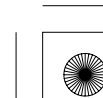
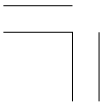



OPERATION

page

1 MOTORCYCLE SAFETY

- 1 IMPORTANT SAFETY INFORMATION
- 3 PROTECTIVE APPAREL
- 5 LOAD LIMITS AND GUIDELINES
- 10 OFF-ROAD SAFETY
- 11 IMAGE LABELS<XL125LK>

16 PARTS LOCATION

- 22 INSTRUMENTS AND INDICATORS

24 MAJOR COMPONENTS

(Information you need to operate this motorcycle)

- 24 BRAKES
- 31 CLUTCH
- 33 FUEL
- 37 ENGINE OIL
- 38 TYRES

page

43 ESSENTIAL INDIVIDUAL COMPONENTS

- 43 IGNITION SWITCH
- 44 RIGHT HANDLEBAR CONTROL <XR125LEK>
- 45 LEFT HANDLEBAR CONTROLS

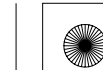



page

46 FEATURES

(Not required for operation)

- 46 STEERING LOCK
- 47 HELMET HOLDER
- 48 SIDE COVERS
- 49 SEAT
- 50 DOCUMENT COMPARTMENT
- 51 HEADLIGHT AIM VERTICAL ADJUSTMENT

page

52 OPERATION

- 52 PRE-RIDE INSPECTION
- 54 STARTING THE ENGINE
- 60 RUNNING-IN
- 61 RIDING
- 63 BRAKING
- 65 PARKING
- 66 ANTI-THEFT TIPS

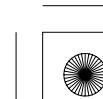



MAINTENANCE

page

67 MAINTENANCE

- 67 THE IMPORTANCE OF MAINTENANCE
- 68 MAINTENANCE SAFETY
- 69 SAFETY PRECAUTIONS
- 70 MAINTENANCE SCHEDULE
- 73 TOOL KIT
- 74 SERIAL NUMBERS
- 75 COLOUR LABEL
- 76 AIR CLEANER
- 77 CRANKCASE BREATHER
- 78 ENGINE OIL
- 82 SPARK PLUG
- 84 THROTTLE OPERATION
- 85 IDLE SPEED
- 86 DRIVE CHAIN
- 93 DRIVE CHAIN SLIDER
- 94 FRONT AND REAR SUSPENSION INSPECTION
- 95 SIDE STAND
- 97 WHEEL REMOVAL
- 103 BRAKE PAD WEAR
- 104 BRAKE SHOE WEAR

page

- 105 BATTERY
- 107 FUSE REPLACEMENT
- 111 BRAKELIGHT SWITCH ADJUSTMENT
- 112 BULB REPLACEMENT

119 CLEANING

122 STORAGE GUIDE

- 122 STORAGE
- 124 REMOVAL FROM STORAGE

125 TAKING CARE OF THE UNEXPECTED

126 SPECIFICATIONS

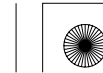



MOTORCYCLE SAFETY

IMPORTANT SAFETY INFORMATION

Your motorcycle can provide many years of service and pleasure — if you take responsibility for your own safety and understand the challenges that you can meet on-road and off-road.

There is much that you can do to protect yourself when you ride. You'll find many helpful recommendations throughout this manual. Following are a few that we consider to be most important.

Always Wear a Helmet

It's a proven fact: helmets significantly reduce the number and severity of head injuries. So always wear an approved motorcycle helmet and make sure your passenger does the same. We also recommend that you wear eye protection, sturdy boots, gloves, and other protective gear (page 3).

Don't Drink and Ride

Alcohol and riding don't mix. Even one drink can reduce your ability to respond to changing conditions, and your reaction time gets worse with every additional drink. So don't drink and ride, and don't let your friends drink and ride either.

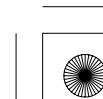
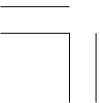



Make Yourself Easy to See On-Road

Some drivers do not see motorcycles because they are not looking for them. To make yourself more visible, wear bright reflective clothing, position yourself so other drivers can see you, signal before turning or changing lanes, and use your horn when it will help others notice you.

Be Alert for Off-Road Hazards

The terrain can present a variety of challenges when you ride off-road. Continually “read” the terrain for unexpected turns, drop-offs, rocks, ruts, and other hazards. Always keep your speed low enough to allow time to see and react to hazards.

Ride Within Your Limits

Pushing the limits is another major cause of motorcycle accident both on-road and off. Never ride beyond your personal abilities or faster than conditions warrant. Remember that alcohol, drugs, fatigue and inattention can significantly reduce your ability to make good judgements and ride safely.

Keep Your Bike in Safe Condition

For safe riding, it’s important to keep your motorcycle properly maintained. Having a breakdown can be difficult, especially if you are stranded off-road far from your base. To help avoid problems, inspect your motorcycle before every ride and perform all recommended maintenance. Never exceed load limits, and use only accessories that have been approved by Honda for this motorcycle. See page 5 for more details.

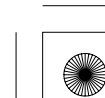
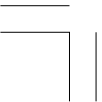



PROTECTIVE APPAREL

For your safety, we strongly recommend that you always wear an approved motorcycle helmet, eye protection, boots, gloves, trousers, and a long-sleeved shirt or jacket whenever you ride. Although complete protection is not possible, wearing proper gear can reduce the chance of injury when you ride.

Following are suggestions to help you choose proper gear.

⚠ WARNING

Not wearing a helmet increases the chance of serious injury or death in a crash.

Be sure you and your passenger always wear a helmet, eye protection and other protective apparel when you ride.

Helmets and Eye Protection

Your helmet is your most important piece of riding gear because it offers the best protection against head injuries. A helmet should fit your head comfortably and securely. A bright-coloured helmet can make you more noticeable in traffic, as can reflective strips.

An open-face helmet offers some protection, but a full-face helmet offers more. Always wear a face shield or goggles to protect your eyes and help your vision.

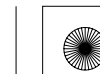



Additional On-road Gear

In addition to a helmet and eye protection, we also recommend:

- Sturdy boots with non-slip soles to help protect your feet and ankles.
- Leather gloves to keep your hands warm and help prevent blisters, cuts, burns and bruises.
- A motorcycle riding suit or jacket for comfort as well as protection. Bright-coloured and reflective clothing can help make you more noticeable in traffic. Be sure to avoid loose clothes that could get caught on any part of your motorcycle.



Additional Off-road Gear

On-road apparel may also be suitable for casual off-road riding. But if you plan on any serious off-road riding you will need more serious off-road gear. In addition to your helmet and eye protection, we recommend off-road motorcycle boots and gloves, riding trousers with knee and hip pads, a jersey with elbow pads, and a chest/shoulder protector.

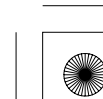
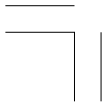



LOAD LIMITS AND GUIDELINES

Your motorcycle has been designed to carry you and one passenger. When you carry a passenger, you may feel some difference during acceleration and braking. But so long as you keep your motorcycle well-maintained, with good tyres and brakes, you can safely carry loads within the given limits and guidelines.

However, exceeding the weight limit or carrying an unbalanced load can seriously affect your motorcycle's handling, braking and stability. Non-Honda accessories, improper modifications, and poor maintenance can also reduce your safety margin.

The following pages give more specific information on loading, accessories and modifications.

Loading

How much weight you put on your motorcycle, and how you load it, are important to your safety. Anytime you ride with a passenger or cargo you should be aware of the following information.

WARNING

Overloading or improper loading can cause a crash and you can be seriously hurt or killed.

Follow all load limits and other loading guidelines in this manual.



Load Limits

Following are the load limits for your motorcycle:

Maximum weight capacity:

159 kg (351 lb)

Includes the weight of the rider, passenger, all cargo and all accessories

Maximum cargo weight:

5 kg (11 lb)

The weight of added accessories will reduce the maximum cargo weight you can carry.

Maximum cargo weight includes the maximum rear carrier cargo weight.

Maximum rear carrier cargo weight:

5 kg (11 lb)

Loading Guidelines

Your motorcycle is primarily intended for transporting you and a passenger. You may wish to secure a jacket or other small items to the seat when you are not riding with a passenger.

If you wish to carry more cargo, check with your dealer for advice, and be sure to read the information regarding accessories on page 8 .

Improperly loading your motorcycle can affect its stability and handling. Even if your motorcycle is properly loaded, you should ride at reduced speeds whenever carrying cargo.

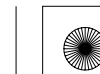



Follow these guidelines whenever you carry a passenger or cargo:

- Check that both tyres are properly inflated (page 38).
- To prevent loose items from creating a hazard, make sure that all cargo is securely tied down before you ride away.
- Place cargo weight as close to the center of the motorcycle as possible.
- Balance cargo weight evenly on both sides.
- Do not attach large or heavy items (such as a sleeping bag or tent) to the handlebars, forks or fender.

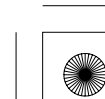



Accessories and Modifications

Modifying your motorcycle or using non-Honda accessories can make your motorcycle unsafe. Before you consider making any modifications or adding an accessory, be sure to read the following information.

⚠ WARNING

Improper accessories or modifications can cause a crash in which you can be seriously hurt or killed.

Follow all instructions in this owner's manual regarding accessories and modifications.

Accessories

We strongly recommend that you use only Honda Genuine Accessories that have been specifically designed and tested for your motorcycle. Because Honda cannot test all other accessories, you must be personally responsible for proper selection, installation and use of non-Honda accessories. Check with your dealer for assistance and always follow these guidelines:

- Make sure the accessory does not obscure any lights, reduce ground clearance and banking angle, limit suspension travel or steering travel, alter your riding position or interfere with operating any controls.
- Be sure electrical equipment does not exceed the motorcycle's electrical system capacity (page 129). A blown fuse can cause a loss of lights or engine power.

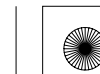



- Do not pull a trailer or sidecar with your motorcycle. This motorcycle was not designed for these attachments, and their use can seriously impair your motorcycle's handling.

Modifications

We strongly advise you not to remove any original equipment or modify your motorcycle in any way that would change its design or operation. Such changes could seriously impair your motorcycle's handling, stability and braking, making it unsafe to ride.

Removing or modifying your exhaust system (such as the spark arresters or mufflers) or other equipment can also make your motorcycle illegal.

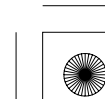
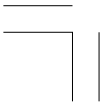



OFF-ROAD SAFETY

Learn to ride in an uncongested off-road area free of obstacles before venturing onto unfamiliar terrain.

- Always obey local off-road riding laws and regulations.
- Obtain permission to ride on private property. Avoid posted areas and obey “NO Trespassing” signs.
- Ride with a friend on another motorcycle so that you can assist each other in case of trouble.
- Familiarity with your motorcycle is critically important should a problem occur far from help.
- Never ride beyond your ability and experience or faster than conditions warrant.
- If you are not familiar with the terrain, ride cautiously. Hidden rocks, holes, or ravines could spell disaster.

- Muffler is required in most off-road areas. Don't modify your exhaust system. Remember that excessive noise bothers everyone and creates a bad image for motorcycling.

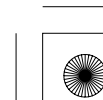
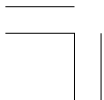

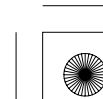

**IMAGE LABELS
(XL125LK)**





The following pages describe the label meanings. Some labels warn you of potential hazards that could cause serious injury. Others provide important safety information. Read this information carefully and don't remove the labels.

There is a specific symbol on each label. The meanings of each symbol and label are as follows.

If a label comes off or becomes hard to read, contact your dealer for a replacement.





	Read instructions contained in Owner's Manual carefully.
	Read instructions contained in Shop Manual carefully. In the interest of safety, take the motorcycle to be serviced only by your dealer.
	DANGER (with RED background) You WILL be KILLED or SERIOUSLY HURT if you don't follow instructions.
	WARNING (with ORANGE background) You CAN be KILLED or SERIOUSLY HURT if you don't follow instructions.
	CAUTION (with YELLOW background) You CAN be HURT if you don't follow instructions.

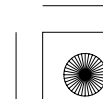
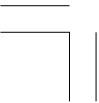

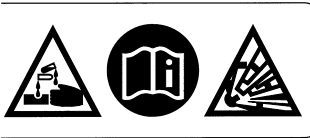
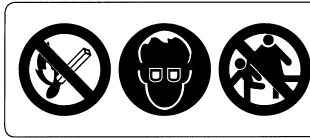

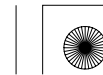

**BATTERY LABEL
DANGER**

- Keep flames and sparks away from the battery. The battery produces explosive gas that can cause an explosion.
- Wear eye protection and rubber gloves when handling the battery to avoid risk of burns or loss of eyesight if exposed to battery electrolyte.
- Do not allow children to handle the battery, under any circumstance. Ensure that anyone handling the battery has a proper understanding of the hazards and correct handling procedures involved.
- Handle battery electrolyte with extreme care, as it contains dilute sulfuric acid. Exposure to eyes or skin can cause burns or loss of eyesight.
- Read this manual carefully, and understand it before handling the battery. Failure to do so can cause personal injury and damage to the vehicle.
- Do not use the battery if the level of electrolyte is at or below the recommended level. Using the battery with low electrolyte can cause it to explode, causing serious injury.





	<p>SAFETY REMINDER LABEL For your protection, always wear helmet and protective gear. FUEL LABEL UNLEADED PETROL ONLY</p>
	<p>DRIVE CHAIN LABEL Keep chain adjusted and lubricated. 20 – 30 mm (0.8 – 1.2 in) Freeplay</p>
	<p>CARGO LIMIT LABEL Do not exceed 5.0 kg (11.0 lb) .</p>

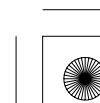
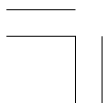



PARTS LOCATION XR125LK/LEK

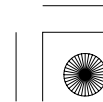
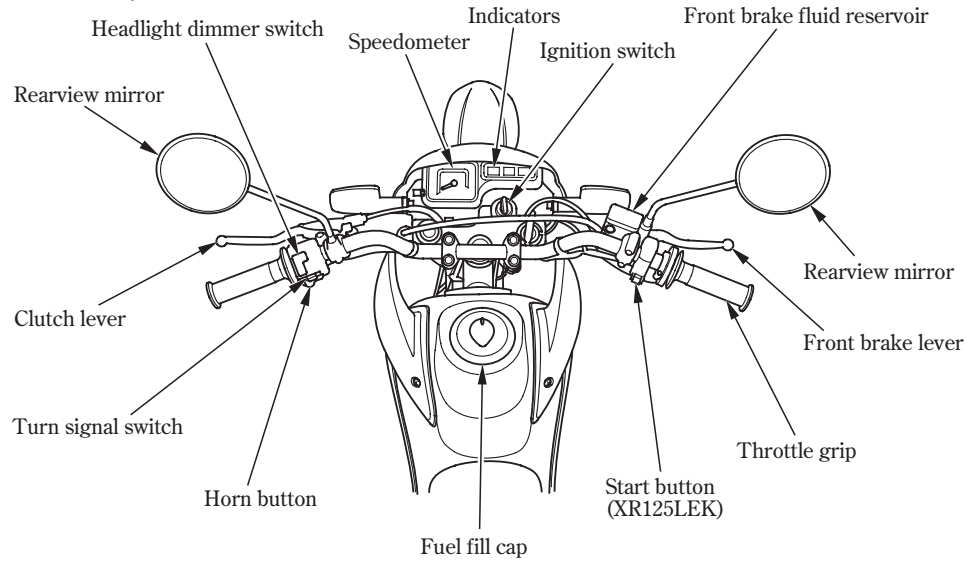



XL125LK

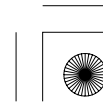
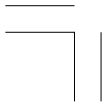
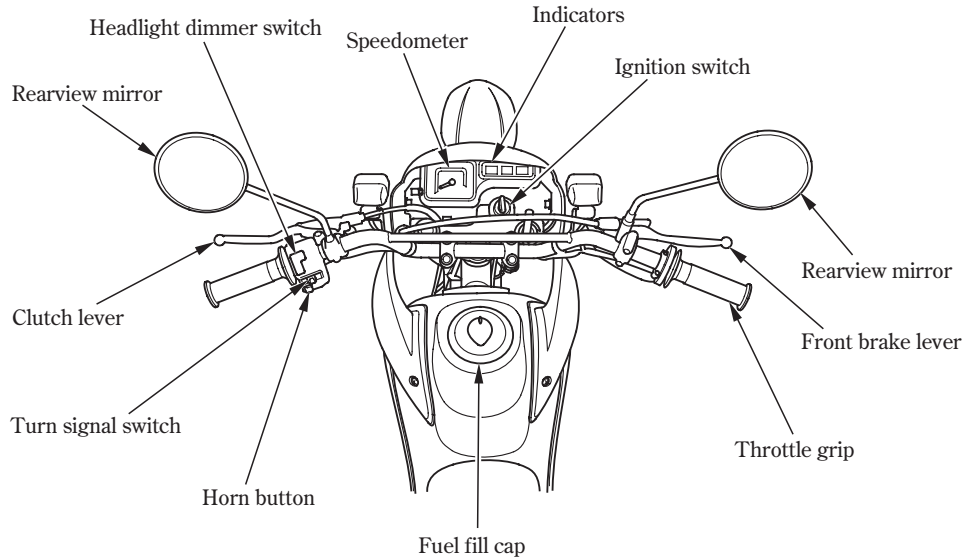



XR125LK/LEK

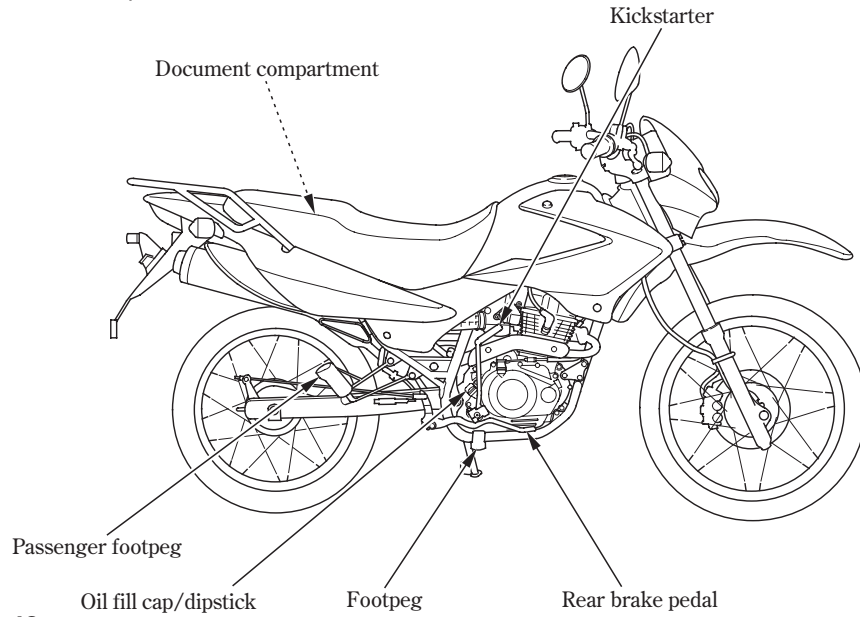

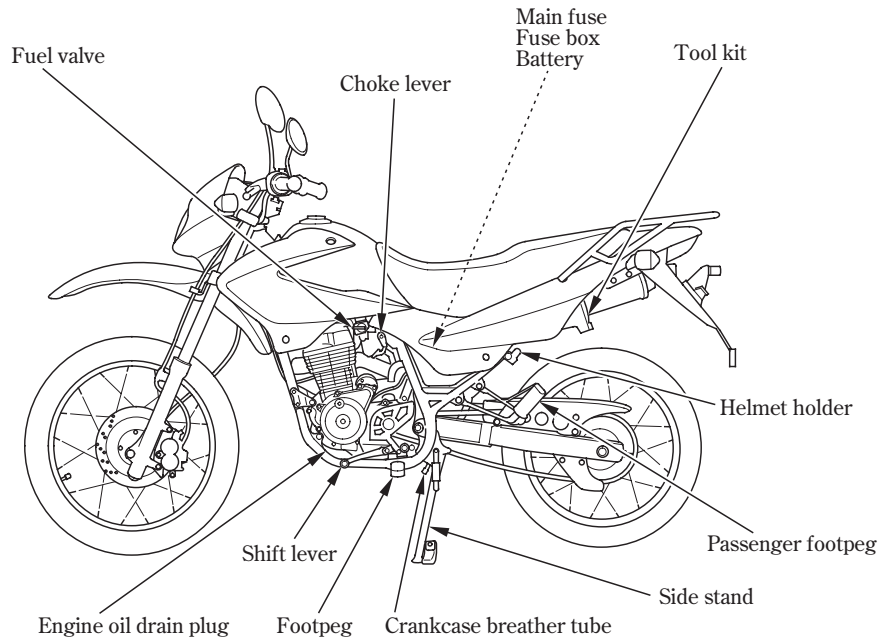



XL125LK

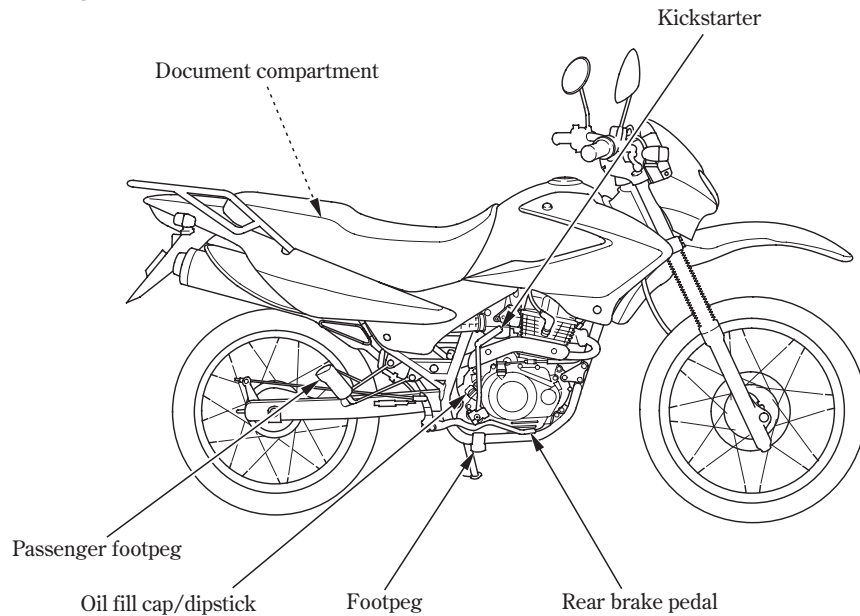

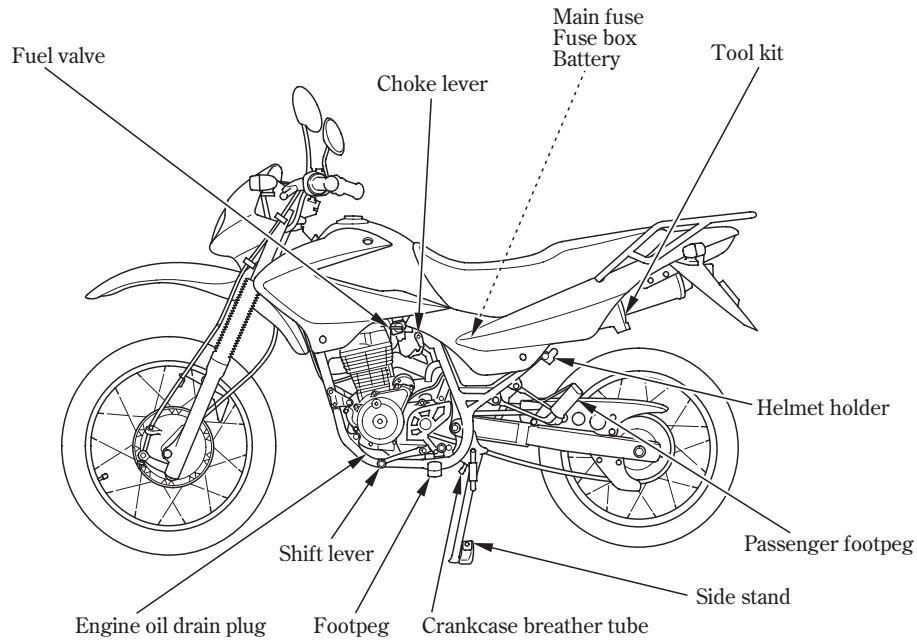



INSTRUMENTS AND INDICATORS

The instruments are grouped together above the headlight case. Their functions are described in the table on the following page.

- (1) Speedometer
- (2) Odometer
- (3) Turn signal indicator
- (4) High beam indicator
- (5) Neutral indicator
- (6) Tripmeter
- (7) Tripmeter reset knob

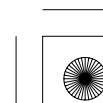
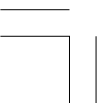
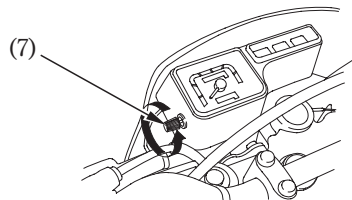
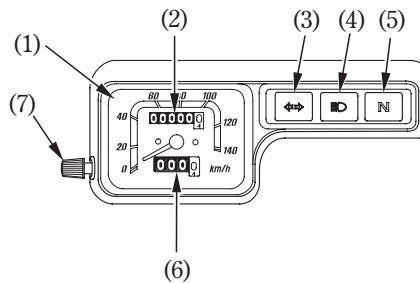



(Ref.No.) Description	Function
(1) Speedometer	Shows riding speed.
(2) Odometer	Shows accumulated mileage.
(3) Turn signal indicator (green)	Flashes when the either turn signal operates.
(4) High beam indicator (blue)	Lights when the headlight is on high beam.
(5) Neutral indicator (green)	Lights when the transmission is in neutral.
(6) Tripmeter	Shows mileage per trip.
(7) Tripmeter reset knob	Resets tripmeter to zero (0). Turn knob in direction shown.

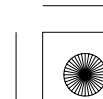
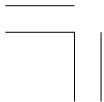



MAJOR COMPONENTS **(Information you need to operate this motorcycle)**

BRAKES

Front Brake (XR125LK/LEK)

This motorcycle has a hydraulic front disc brake.

As the brake pads wear, brake fluid level drops.

There are no adjustments to perform, but fluid level and pad wear must be inspected periodically. The system must be inspected frequently to ensure there are no fluid leaks. If the brake lever free travel becomes excessive and the brake pads are not worn beyond the recommended limit (page 103), there is probably air in the brake system and it must be bled. See your dealer for this service.

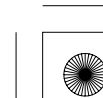
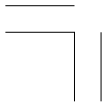



Brake Fluid Level:

With the motorcycle in an upright position, check the fluid level. It should be above the LOWER level mark (1). If the level is at or below the LOWER level mark (1), check the brake pads for wear (page 103).

Worn pads should be replaced. If the pads are not worn, have your brake system inspected for leaks.

The recommended brake fluid is Honda DOT 3 or DOT 4 brake fluid from a sealed container, or an equivalent.

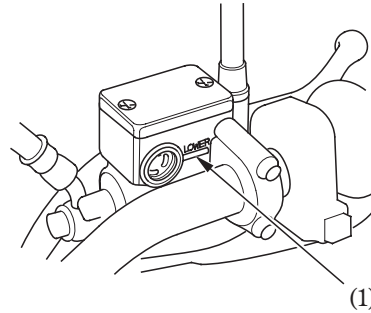

(1) LOWER level mark

Other Checks:

Make sure there are no fluid leaks. Check for deterioration or cracks in the hoses and fittings.

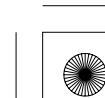
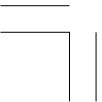



Front Brake (XL125LK)

Brakes are items of personal safety and should always be maintained in proper adjustment.

The distance of the front brake lever moves before the brake starts to engage is called freeplay.

Measured at the tip of the front brake lever (1), freeplay should be maintained at:

10–20 mm (0.4–0.8 in)

Adjust the freeplay of the brake lever with the front wheel pointed straight ahead.

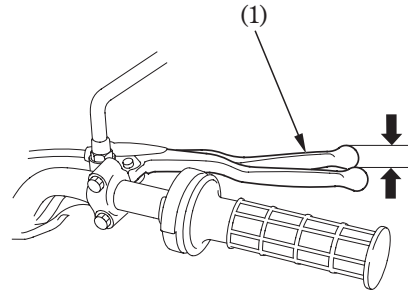

(1) Front brake lever

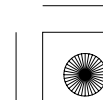
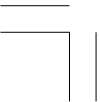



Adjustment:

1. Adjust brake lever freeplay with the front brake adjusting nut (2). Turning the nut clockwise will decrease freeplay and turning the nut counterclockwise will increase freeplay.

Make sure the cut-out on the adjusting nut is seated on the brake arm pin (3) after making final freeplay adjustment.

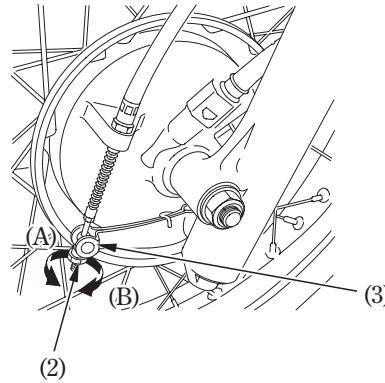

- (2) Front brake adjusting nut
- (3) Brake arm pin

- (A) Decrease freeplay
- (B) Increase freeplay

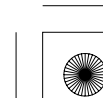
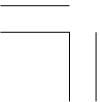



2. Apply the brake several times and check for free wheel rotation after the brake lever is released.

After adjustment, push the brake arm (4) to confirm that there is a gap between the front brake adjusting nut (2) and the brake arm pin (3).

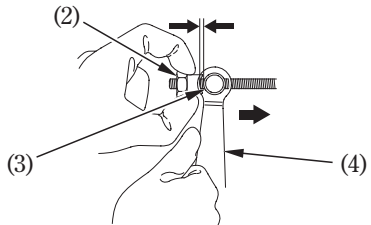

(2) Front brake adjusting nut (4) Brake arm
(3) Brake arm pin

After adjustment, confirm the freeplay of the brake lever.

If proper adjustment cannot be obtained by this method, see your dealer.

Other Checks:

Check the brake cable for kinks or signs of wear that could cause sticking or failure. Lubricate the brake cable with a commercially available cable lubricant to prevent premature wear and corrosion. Make sure the brake arm, spring and fasteners are in good condition.



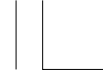

Rear Brake

Pedal Height Adjustment:

The stopper bolt (1) is provided to allow adjustment of the pedal height. To adjust the pedal height, loosen the lock nut (2) and turn the stopper bolt. Tighten the lock nut.

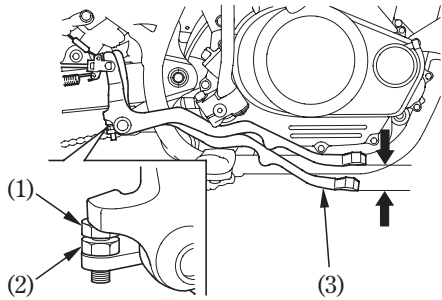

- (1) Stopper bolt
- (2) Lock nut
- (3) Rear brake pedal

Brake Adjustment:

1. Place the motorcycle on its side stand.
2. Measure the distance the rear brake pedal (3) moves before the brake starts to take hold.

Freeplay should be:

15 – 25 mm (0.6 – 1.0 in)

3. If adjustment is necessary, turn the rear brake adjusting nut (4).

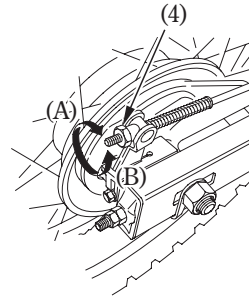

- (4) Rear brake adjusting nut
- (A) Decrease freeplay
- (B) Increase freeplay

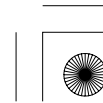
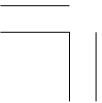



Adjust by turning the rear brake adjusting nut a half-turn at a time. Make sure the cut-out on the adjusting nut is seated on the brake arm pin (5) after making final freeplay adjustment.

4. Apply the brake several times and check for free wheel rotation after the brake pedal is released.

If proper adjustment cannot be obtained by this method, see your dealer.

After adjustment, push the brake arm (6) to confirm that there is a gap between the rear brake adjusting nut (4) and the brake arm pin (5).

After adjustment, confirm the freeplay of the brake pedal.

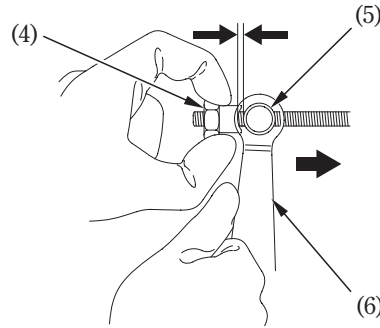

- (4) Rear brake adjusting nut
- (5) Brake arm pin
- (6) Brake arm

Other Checks:

Make sure the brake arm, brake rod, spring and fasteners are in good condition.

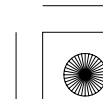



CLUTCH

Clutch adjustment may be required if the motorcycle stalls when shifting into gear or tends to creep; or if the clutch slips, causing acceleration to lag behind engine speed. Minor adjustments can be made with the clutch cable adjuster (1) at the clutch lever (2).

Normal clutch lever freeplay is:
10–20 mm (0.4–0.8 in)

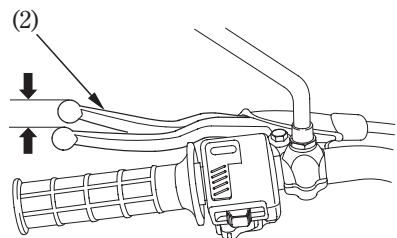

(2) Clutch lever

1. Pull back the rubber dust cover (3).
2. Loosen the lock nut (4) and turn the clutch cable adjuster. Tighten the lock nut and check the adjustment.
3. If the adjuster is threaded out near its limit or if the correct freeplay cannot be obtained, using the clutch cable adjuster, loosen the lock nut and turn in the clutch cable adjuster completely. Tighten the lock nut and install the rubber dust cover.

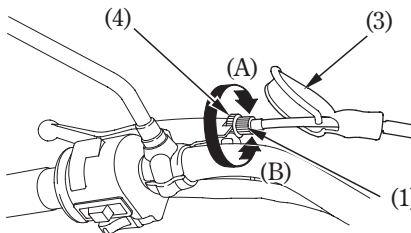

- (1) Clutch cable adjuster (A) Increase freeplay
 (3) Rubber dust cover (B) Decrease freeplay
 (4) Lock nut

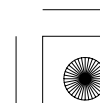
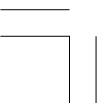



4. Loosen the lock nut (5) at the lower end of the cable. Turn the adjusting nut (6) to obtain the specified freeplay. Tighten the lock nut and check the adjustment.
5. Start the engine, pull in the clutch lever and shift into gear. Make sure the engine does not stall and the motorcycle does not creep. Gradually release the clutch lever and open the throttle. The motorcycle should begin to move smoothly and accelerate gradually.

If proper adjustment cannot be obtained or the clutch does not work correctly, see your dealer.

Other Checks:

Check the clutch cable for kinks or signs of wear that could cause sticking or failure. Lubricate the clutch cable with a commercially available cable lubricant to prevent premature wear and corrosion.

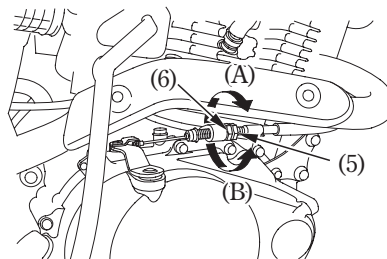

- (5) Lock nut
- (6) Adjusting nut

- (A) Increase freeplay
- (B) Decrease freeplay

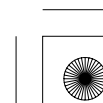
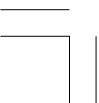



FUEL Fuel Valve

The three way fuel valve (1) is on the left side near the carburetor.

OFF

With the fuel valve in the OFF position, fuel cannot flow from the tank to the carburetor. Turn the valve OFF whenever the motorcycle is not in use.

ON

With the fuel valve in the ON position, fuel will flow from the main fuel supply to the carburetor.

RES

With the fuel valve in the RES position, fuel will flow from the reserve fuel supply to the carburetor. Use the reserve fuel only when the main supply is gone. Refill the tank as soon as possible after switching to RES.

The reserve fuel supply is:

3.2 ℓ (0.85 US gal , 0.70 Imp gal)

Remember to check that the fuel valve is in the ON position each time you refuel. If the valve is left in the RES position, you may run out of fuel with no reserve.

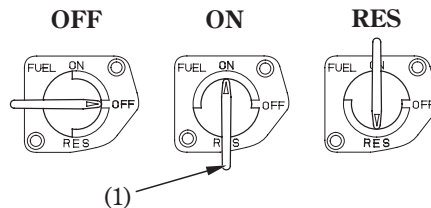

(1) Fuel valve

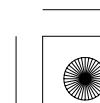
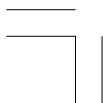



Fuel Tank

The fuel tank capacity including the reserve supply is:

12.0 ℓ (3.17 US gal , 2.64 Imp gal)

To open the fuel fill cap (1), open the tank cap cover (2), insert the ignition key (3) and turn it clockwise. The fuel fill cap will pop up and can be lifted off.

After refueling, to close the fuel fill cap, align the latch in the cap with the slot in the filler neck (4). Push the fuel fill cap into the filler neck until it snaps closed and locks. Remove the key.

⚠ WARNING

Petrol is highly flammable and explosive. You can be burned or seriously injured when handling fuel.

- Stop the engine and keep heat, sparks, and flame away.
- Refuel only outdoors.
- Wipe up spills immediately.

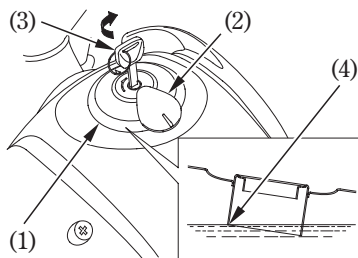

- (1) Fuel fill cap (3) Ignition key
(2) Tank cap cover (4) Filler neck

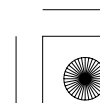
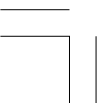



Use unleaded petrol with a research octane number of 91 or higher.

NOTICE

If “spark knock” or “pinking” occurs at a steady engine speed under normal load, change brands of petrol. If spark knock or pinking persists, consult your dealer. Failure to do so is considered misuse, and damage caused by misuse is not covered by Honda’s Limited Warranty.

Occasionally you may experience light spark knock while operating under heavy loads. This is no cause for concern, it simply means your engine is operating efficiently.

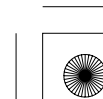



Petrol Containing Alcohol

If you decide to use a petrol containing alcohol (gasohol), be sure it's octane rating is at least as high as that recommended by Honda. There are two types of "gasohol": one containing ethanol, and the other containing methanol. Do not use petrol that contains more than 10 % ethanol. Do not use petrol containing methanol (methyl or wood alcohol) that does not also contain cosolvents and corrosion inhibitors for methanol. Never use petrol containing more than 5 % methanol, even if it has cosolvents and corrosion inhibitors.

The use of petrol containing more than 10 % ethanol (or more than 5 % methanol) may:

- Damage the painting of the fuel tank.
- Damage the rubber tubes of the fuel line.
- Cause corrosion of the fuel tank.
- Cause poor drivability.

Before buying fuel from an unfamiliar station, try to find out if the fuel contains alcohol. If it does, confirm the type and percentage of alcohol used. If you notice any undesirable operating symptoms while using a petrol that contains alcohol, or one that you think contains alcohol, switch to a petrol that you know does not contain alcohol.

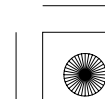



ENGINE OIL

Engine Oil Level Check

Check the engine oil level each day before riding the motorcycle.

The level must be maintained between the upper (1) and lower (2) level marks on the oil fill cap/dipstick (3).

1. Start the engine and let it idle for 3–5 minutes.
2. Stop the engine and hold the motorcycle in an upright position on firm, level ground.
3. After 2–3 minutes, remove the oil fill cap/dipstick, wipe it clean, and reinsert the oil fill cap/dipstick without screwing it in. Remove the oil fill cap/dipstick. The oil level should be between the upper and lower level marks on the oil fill cap/dipstick.
4. If required, add the specified oil (see page 78) up to the upper level mark. Do not overfill.

5. Reinstall the oil fill cap/dipstick. Check for oil leaks.

NOTICE

Running the engine with insufficient oil pressure may cause serious engine damage.

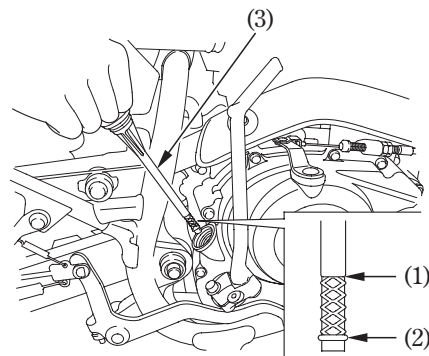

- (1) Upper level mark
- (2) Lower level mark
- (3) Oil fill cap/dipstick





TYRES

To safely operate your motorcycle, the tyres must be the proper type (off-road) and size, in good condition with adequate tread, and correctly inflated.

⚠ WARNING

Using tyres that are excessively worn or improperly inflated can cause a crash in which you can be seriously hurt or killed.

Follow all instructions in this owner's manual regarding tyre inflation and maintenance.

Air Pressure

Properly inflated tyres provide the best combination of handling, tread life, and riding comfort. Generally, underinflated tyres wear unevenly, adversely affect handling, and are more likely to fail from being overheated. Underinflated tyres can also cause wheel damage in rocky terrain. Overinflated tyres make your motorcycle ride harshly, are more prone to damage from surface hazards, and wear unevenly.

Make sure the valve stem caps are secure. If necessary, install new caps.

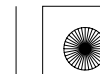



Always check air pressure when your tyres are “cold” – when the motorcycle has been parked for at least three hours. If you check air pressure when your tyres are “warm” – when the motorcycle has been ridden for even a few miles – the readings will be higher than if the tyres were “cold”. This is normal, so do not let air out of the tyres to match the recommended cold air pressures given below. If you do, the tyres will be underinflated.

The recommended “cold” tyre pressures are:

kPa (kgf/cm ² , psi)	
Driver only	Front 150 (1.50 , 22) Rear 150 (1.50 , 22)
Driver and one passenger	Front 150 (1.50 , 22) Rear (XR125LK/LEK) 200 (2.00 , 29) (XL125LK) 225 (2.25 , 33)

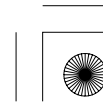



Inspection

Whenever you check the tyre pressures, you should also examine the tyre treads and sidewalls for wear, damage, and foreign objects:

Look for:

- Bumps or bulges in the side of the tyre or the tread. Replace the tyre if you find any bumps or bulges.
- Cuts, splits or cracks in the tyre. Replace the tyre if you can see fabric or cord.
- Excessive tread wear.

Also, if you hit a pothole or hard object, pull to the side of the road as soon as you can safely and carefully inspect the tyres for damage.

Tread Wear

Replace tyres before tread depth (1) at the center of the tyre reaches the following limit:

Minimum tread depth	
Front:	3.0 mm (0.12 in)
Rear:	3.0 mm (0.12 in)

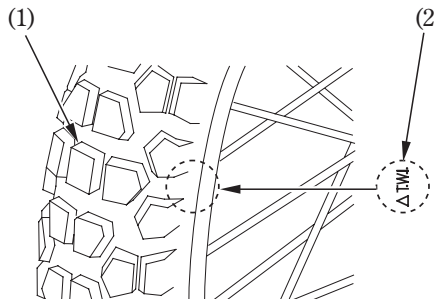

- (1) Tyre tread depth
- (2) Wear indicator location mark

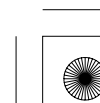
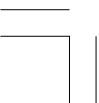



Tube Repair and Replacement

If a tube is punctured or damaged, you should replace it as soon as possible. A tube that is repaired may not have the same reliability as a new one, and it may fail while you are riding.

If you need to make a temporary repair by patching a tube or using an aerosol sealant, ride cautiously at reduced speed and have the tube replaced before you ride again. Any time a tube is replaced, the tyre should be carefully inspected as described on page 39 .



Tyre Replacement

The tyres that came on your motorcycle were designed to match the performance capabilities of your motorcycle and provide the best combination of handling, braking, durability and comfort.

WARNING

Installing improper tyres on your motorcycle can affect handling and stability. This can cause a crash in which you can be seriously hurt or killed.

Always use the size and type of tyres recommended in this owner's manual.

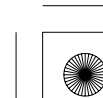
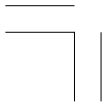



The recommended tyres for your motorcycle are:

(XR125LK/LEK)

Front: 90/90 – 19M/C 52P
CHENG SHIN
C6559F

Rear: 110/90 – 17M/C 60P
CHENG SHIN
C6559

Type: bias-ply, tube

(XL125LK)

Front: 70/100 – 21M/C 44P
CHENG SHIN
CM-704

Rear: 100/90 – 18M/C 56P
CHENG SHIN
CM-705

Type: bias-ply, tube

Whenever you replace a tyre, use one that is equivalent to the original and be sure the wheel is balanced after the new tyre is installed.

Also remember to replace the inner tube whenever you replace a tyre. The old tube will probably be stretched, and if installed in a new tyre, it could fail.

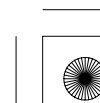
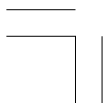



ESSENTIAL INDIVIDUAL COMPONENTS

IGNITION SWITCH

The ignition switch (1) is below the indicator panel.

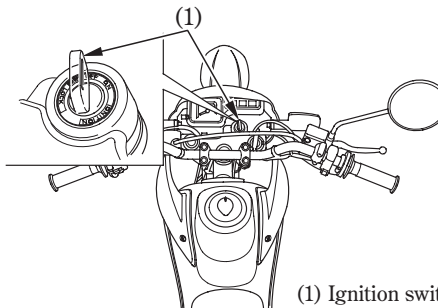

(1) Ignition switch

Key Position	Function	Key Removal
LOCK (Steering lock)	Steering is locked. Engine and lights cannot be operated.	Key can be removed
OFF	Engine and lights cannot be operated.	Key can be removed
ON	Engine can be operated. The brakelight, turn signals and horn can be operated. The headlight, position light, taillight, license light (XR125LK/LEK) and meter light operate only when the engine is running.	Key cannot be removed





RIGHT HANDLEBAR CONTROL

(XR125LEK)

Start Button(XR125LEK)

The start button (1) is next to the throttle grip.

When the start button is pressed, the starter motor cranks the engine. See page 55 for the starting procedure.

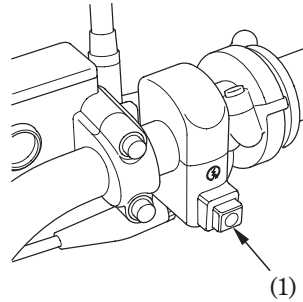

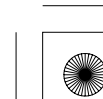
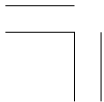

(1) Start button





LEFT HANDLEBAR CONTROLS

Headlight Dimmer Switch (1)

Push the dimmer switch to  (HI) to select high beam or to  (LO) to select low beam.

Turn Signal Switch (2)

Move to  to signal a left turn,  to signal a right turn. Press to turn signal off.

Horn Button (3)

Press the button to sound the horn.

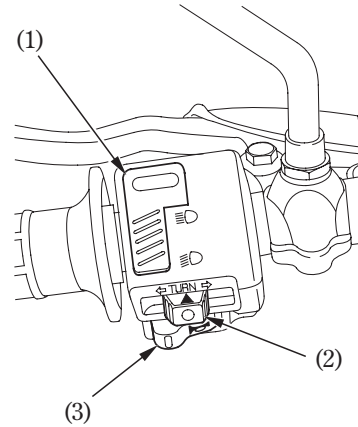

- (1) Headlight dimmer switch
- (2) Turn signal switch
- (3) Horn button

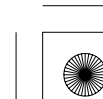
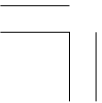



FEATURES (Not required for operation)

STEERING LOCK

The steering can be locked when the ignition switch (1) is in the "LOCK" position.

To lock the steering, turn the handlebar all the way to the left, turn the ignition key (1) to LOCK while pushing in. Remove the key. To unlock the steering, turn the key to OFF while pushing in.

Do not turn the key to LOCK while riding the motorcycle; loss of vehicle control will result.

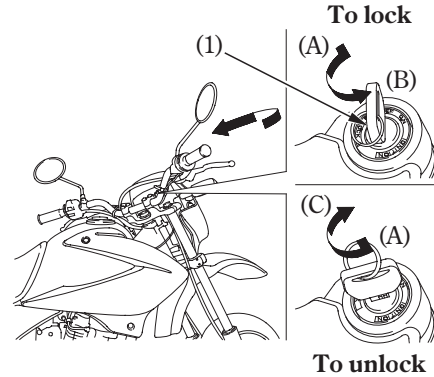

(1) Ignition key

- (A) Push in
- (B) Turn to LOCK
- (C) Turn to OFF

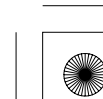



HELMET HOLDER

The helmet holder (1) is on the left side below the left side cover. The helmet holder is designed to secure your helmet while parked.

Insert the ignition key (2) and turn it counterclockwise to unlock.

Hang your helmet on the holder pin (3) and push it in to lock. Remove the key.

WARNING

Riding with a helmet attached to the holder can interfere with the rear wheel or suspension and could cause a crash in which you can be seriously hurt or killed.

Use the helmet holder only while parked. Do not ride with a helmet secured by the holder.

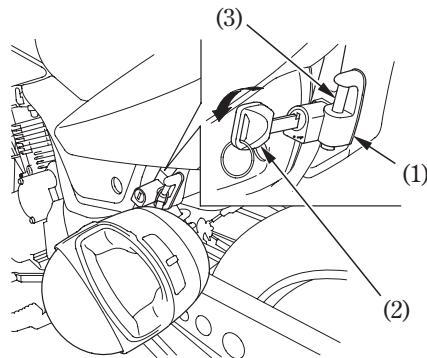

(1) Helmet holder
(2) Ignition key

(3) Holder pin





SIDE COVERS

The right side cover must be removed for seat removal.

The left side cover must be removed for seat removal, or to service the fuse or battery maintenance.

The right and left side covers can be removed in the same manner.

Removal:

1. Remove the bolt (1) and collar (2).
2. Remove the side cover (3), then remove the prongs (4) from the grommets (5).

Installation:

1. Align the prongs with the grommets.
2. Press the side cover into position.
3. Install the collar and tighten the bolt.

LEFT SIDE

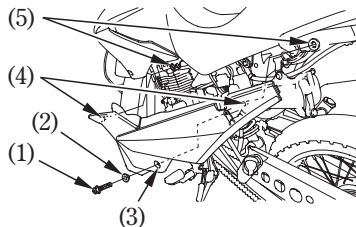

RIGHT SIDE

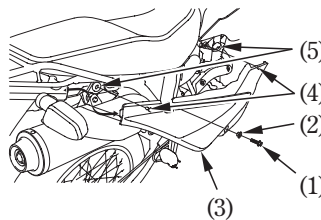

- | | |
|----------------|--------------|
| (1) Bolt | (4) Prongs |
| (2) Collar | (5) Grommets |
| (3) Side cover | |

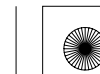



SEAT

The seat must be removed to access the owner's manual.

Removal:

1. Remove the right and left side covers (page 48).
2. Remove the bolts (1) and collars (2).
3. Slide the seat (3) back.

Installation:

1. Align the front recesses (4) to the front hooks (5) of the frame cross member, and rear recess (6) to the rear hook (7).
2. Slide the seat into position.
3. Install the collars and tighten the bolts.
4. Install the both side covers.

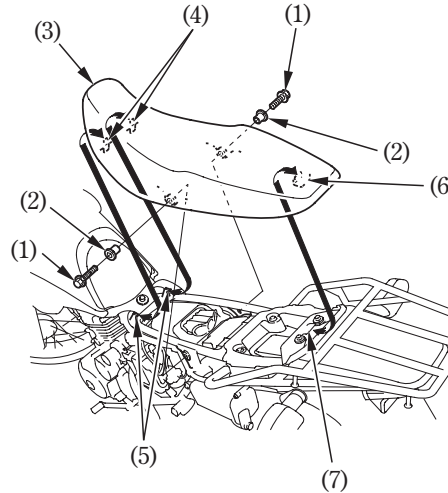

- | | |
|--------------------|-----------------|
| (1) Bolts | (5) Front hooks |
| (2) Collars | (6) Rear recess |
| (3) Seat | (7) Rear hook |
| (4) Front recesses | |

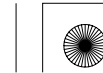



DOCUMENT COMPARTMENT

The document bag (1) is put into the document compartment (2) under the seat (page 49).

This owner's manual and other documents should be stored in the document bag. When washing your motorcycle, be careful not to flood this area with water.

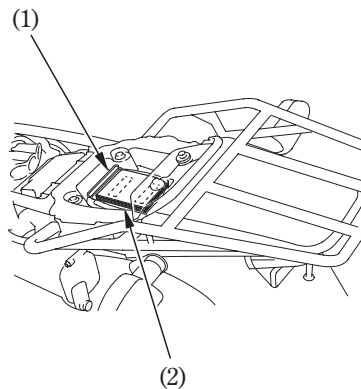

- (1) Document bag
- (2) Document compartment

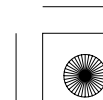
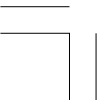

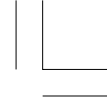

HEADLIGHT AIM VERTICAL ADJUSTMENT

Vertical adjustment can be made by turning
the screw (1) in or out as necessary.
Obey local laws and regulations.

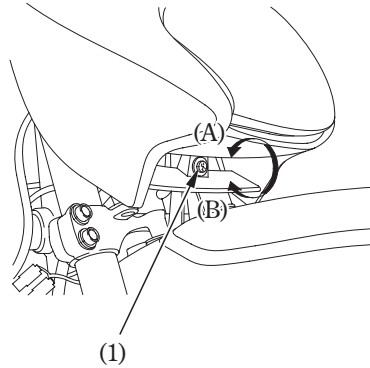

(1) Screw

(A) Up
(B) Down

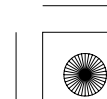
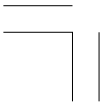



OPERATION

PRE-RIDE INSPECTION

To ensure safety, it is your responsibility to perform a pre-ride inspection and make sure that any problem you find is corrected. A pre-ride inspection is a must, not only for safety, but because having a breakdown, or even a flat tyre, can be a major inconvenience.

WARNING

Improperly maintaining this motorcycle or failing to correct a problem before riding can cause a crash in which you can be seriously hurt or killed.

Always perform a pre-ride inspection before every ride and correct any problems.

Check the following items before you ride motorcycle:

- Fuel level—Fill fuel tank when necessary (page 34).
- Throttle—Check for smooth opening and full closing in all steering positions.
- Engine oil level—Add engine oil if necessary (page 37). Check for leaks.
- Drive chain—Check condition and slack, adjust and lubricate if necessary (page 86).
- Brakes — Check operation;
(XR125LK/LEK)
Front: check brake fluid level (page 25) and pads wear (page103).
Rear: check shoes wear (page104) and freeplay, adjust if necessary (pages 29 – 30).
(XL125LK)
Front and Rear: check shoes wear (page 104) and freeplay, adjust if necessary (pages 26 – 30).

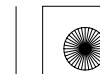



- Lights and horn—Check that lights, indicators and horn function properly.
- Clutch—Check operation; Adjust freeplay if necessary (page 31).
- Side stand ignition cut-off system (**XR125LK/LEK**) —Check for proper function (page 96).
- Wheels and tyres — Check condition, air pressure and adjust if necessary (pages 38 — 40).

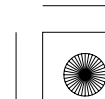
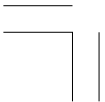



STARTING THE ENGINE

Always follow the proper starting procedure described below.

(except NZ type)

This motorcycle can be started with the transmission in gear by disengaging the clutch before operating the starter.

(NZ type only)

This motorcycle is equipped with a side stand ignition cut-off system. The engine cannot be started if the side stand is down, unless the transmission is in neutral. If the side stand is up, the engine can be started in neutral or in gear with the clutch lever pulled in. After starting with the side stand down, the engine will shut off if the transmission is put in gear before raising the side stand.

Your motorcycle's exhaust contains poisonous carbon monoxide gas. High levels of carbon monoxide can collect rapidly in enclosed areas such as a garage. Do not run the engine with the garage door closed. Even with the door open, run the engine only long enough to move your motorcycle out of the garage.

(XR125LEK)

Do not use the electric starter for more than 5 seconds at a time. Release the start button for approximately 10 seconds before pressing it again.

Do not operate the kickstarter while the engine is running as engine damage could result. Do not apply excessive force on the kickstarter.

Fold up the kickstarter after the kickstarter is returned to the pedal stop.

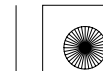



Preparation

Before starting, insert the key, turn the ignition switch ON and confirm the following:

- The transmission is in neutral (neutral indicator is ON).
- The fuel valve is ON.

Starting Procedure (XR125LK/LEK)

Cold Engine:

1. Pull the choke lever (1) up all the way to Fully ON (A).

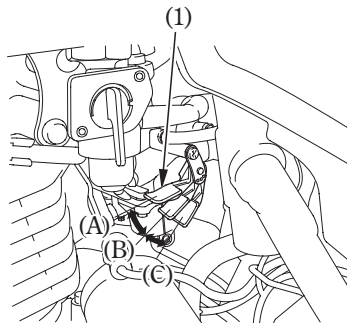

(1) Choke lever

(A) Fully ON

(B) Halfway Position

(C) Fully OFF

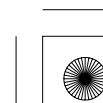
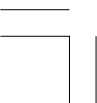



2. <Using the start button **(XR125LEK)**>

With the throttle 1/8–1/4 open, press the start button.

<Using the kickstarter>

Lightly depress the kickstarter until resistance is felt.

Then let kickstarter return to the top of its stroke.

With the throttle 1/8–1/4 open, operate the kickstarter.

Kick from the top of the stroke through to the bottom with a rapid, continuous motion.

3. Immediately after the engine starts, push the choke lever (1) down to the Halfway Position (B).

4. Warm up the engine by opening and closing the throttle slightly.

5. Continue warming up the engine until it runs smoothly and responds to the throttle, when the choke lever (1) is at Fully OFF (C).

Warm Engine:

1. Do not use the choke.

2. Start the engine following step 2 under “Cold Engine”.

(XL125LK)

Cold Engine:

1. Pull the choke lever (1) up all the way to Fully ON (A).

2. Lightly depress the kickstarter until resistance is felt.

Then let kickstarter return to the top of its stroke.

With the throttle 3 mm open, operate the kickstarter.

Kick from the top of the stroke through to the bottom with a rapid, continuous motion.

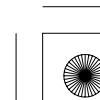
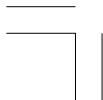



3. Immediately after the engine starts, push the choke lever (1) down to the Halfway Position (B).
4. Warm up the engine by opening and closing the throttle slightly.
5. Continue warming up the engine until it runs smoothly and responds to the throttle, when the choke lever (1) is at Fully OFF (C).

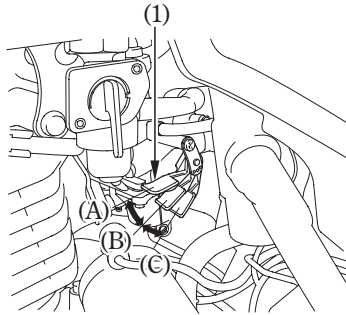

Warm Engine:

1. Do not use the choke.
2. Start the engine following step 2 under "Cold Engine".

(1) Choke lever

- (A) Fully ON
- (B) Halfway Position
- (C) Fully OFF

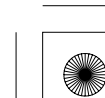
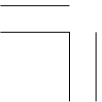



(NZ/ILA/DK/IIDK type only)

Your motorcycle's carburetor is equipped with a heater.

Your carburetor is suitable for use in cold regions.

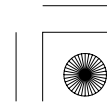
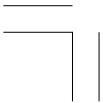



Flooded Engine

If the engine fails to start after repeated attempts, it may be flooded.

〈Using the start button **(XR125LEK)**〉

1. Turn the ignition switch to ON.
2. Push the choke lever down all the way to Fully OFF (C).
3. Open throttle fully.
4. Press the start button for 5 seconds.
5. Follow the normal starting procedure.
If the engine starts with unstable idle, open the throttle slightly.
6. If the engine does not start, wait for 10 seconds, then follow steps 1–5 again.



〈Using the kickstarter〉

1. Turn the ignition switch to OFF.
2. Push the choke lever down all the way to Fully OFF (C).
3. Open the throttle fully and crank the engine several times with the kickstarter.
4. Turn the ignition switch to ON.
5. Follow the normal starting procedure.
6. If the engine starts with unstable idle, open the throttle slightly.

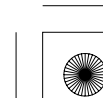
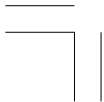

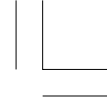

RUNNING-IN

Help assure your motorcycle's future reliability and performance by paying extra attention to how you ride during the first 500 km (300 miles). During this period, avoid full-throttle starts and rapid acceleration.

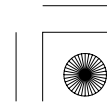
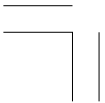



RIDING

Review Motorcycle Safety (pages 1 – 10) before you ride.

(except NZ type)

Make sure the side stand is fully retracted before riding the motorcycle. If the stand is extended, it may interfere with control during a left turn.

(NZ type only)

Make sure you understand the function of the side stand mechanism. (See MAINTENANCE SCHEDULE on page 72 and explanation for SIDE STAND on page 96).

1. After the engine has been warmed up, the motorcycle is ready for riding.
2. While the engine is idling, pull in the clutch lever and depress the shift lever to shift into 1st (low) gear.

3. Slowly release the clutch lever and at the same time gradually increase engine speed by opening the throttle. Coordination of the throttle and clutch lever will assure a smooth positive start.
4. When the motorcycle attains a moderate speed, close the throttle, pull in the clutch lever and shift to 2nd gear by raising the shift lever.

This sequence is repeated to progressively shift to 3rd, 4th and 5th (top) gears.

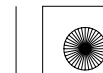
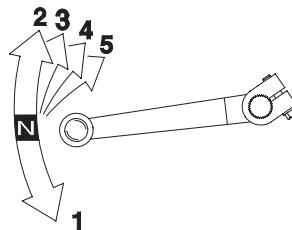



5. Raise the shift lever to shift to a higher gear and depress the shift lever to shift to a lower gear. Each stroke of the shift lever engages the next gear in sequence. The shift lever automatically returns to the horizontal position when released.
 6. Coordinate the throttle and brakes for smooth deceleration.
 7. Both front and rear brakes should be used at the same time and should not be applied strongly enough to lock the wheel, or braking effectiveness will be reduced and control of the motorcycle be difficult.
- Do not downshift when traveling at a speed that would force the engine to overrev in the next lower gear; the rear wheel may lose traction, resulting in a possible loss of vehicle control.
 - Do not shift gears without disengaging the clutch and closing the throttle. The engine and drive train could be damaged by overspeed and shock.
 - Do not tow the motorcycle or coast for long distances while the engine is off. The transmission will not be properly lubricated and damage may result.
 - Do not run the engine at high rpm with the transmission in neutral or the clutch lever pulled in. Serious engine damage may result.

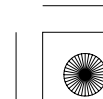
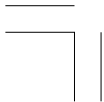



**BRAKING
(XR125LK/LEK)**

Your motorcycle is equipped with a hydraulically-activated disc brake in front and a mechanically-activated drum brake at the rear. Operating the brake lever applies the front disc brake. Depressing the brake pedal applies the rear drum brake.

For normal braking, gradually apply both the front and rear brakes while downshifting to suit your road speed.

For maximum deceleration, close the throttle and apply the front and rear brakes firmly. Pull in the clutch lever before coming to a complete stop to prevent stalling the engine.

(XL125LK)

Your motorcycle is equipped with mechanically-activated drum brakes. Operating the brake lever applies the front drum brake. Depressing the brake pedal applies the rear drum brake.

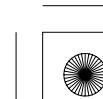
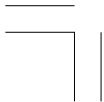



Important Safety Reminders:

- Independent operation of only the brake lever or brake pedal reduces stopping performance.
- Extreme application of the brake controls may cause wheel lock, reducing control of the motorcycle.
- When possible, reduce speed or brake before entering a turn; closing the throttle or braking in mid-turn may cause wheel slip. Wheel slip will reduce control of the motorcycle.
- When riding in wet or rainy conditions, or on loose surfaces, the ability to maneuver and stop will be reduced. All of your actions should be smooth under these conditions. Rapid acceleration, braking or turning may cause loss of control. For your safety, exercise extreme caution when braking, accelerating or turning.
- When descending a long, steep grade, use engine compression braking by downshifting, with intermittent use of both brakes. Continuous brake application can overheat the brakes and reduce their effectiveness.
- Riding with your foot resting on the brake pedal or your hand on the brake lever may actuate the brakelight, giving a false indication to other drivers. It may also overheat the brakes, reducing effectiveness.

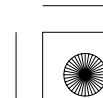



PARKING

1. After stopping the motorcycle, shift the transmission into neutral, turn the fuel valve OFF, turn the handlebar fully to the left, turn the ignition switch OFF and remove the key.
2. Use the side stand to support the motorcycle while parked.
3. Lock the steering to help prevent theft (page 46).

Park the motorcycle on firm, level ground to prevent it from falling over.

If you must park on a slight incline, aim the front of the motorcycle uphill to reduce the possibility of rolling off the side stand or overturning.

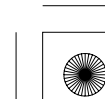



ANTI-THEFT TIPS

1. Always lock the steering and never leave the key in the ignition switch. This sounds simple but people do forget.
2. Be sure the registration information for your motorcycle is accurate and current.
3. Park your motorcycle in a locked garage whenever possible.
4. Use an additional anti-theft device of good quality.
5. Put your name, address, and phone number in this Owner's Manual and keep it on your motorcycles at all times. Many times stolen motorcycles are identified by information in the Owner's Manuals that are still with them.

NAME: _____

ADDRESS: _____

PHONE NO: _____

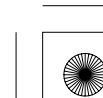



MAINTENANCE

THE IMPORTANCE OF MAINTENANCE

A well-maintained motorcycle is essential for safe, economical and trouble-free riding. It will also help reduce air pollution.

Because this motorcycle is capable of being ridden over rough off-road terrain as well as on pavement, careful pre-ride inspections and good maintenance are especially important.

To help you properly care for your motorcycle, the following pages include a Maintenance Schedule and a Maintenance Record for regularly scheduled maintenance.

These instructions are based on the assumption that the motorcycle will be used exclusively for its designed purpose. Sustained high speed operation or operation in unusually wet or dusty conditions will require more frequent service than specified in the Maintenance Schedule. Consult your dealer for recommendations

applicable to your individual needs and use.

If your motorcycle overturns or becomes involved in a crash, be sure your dealer inspects all major parts, even if you are able to make some repairs.

⚠ WARNING

Improperly maintaining this motorcycle or failing to correct a problem before you ride can cause a crash in which you can be seriously hurt or killed.

Always follow the inspection and maintenance recommendations and schedules in this owner's manual.

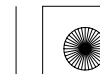



MAINTENANCE SAFETY

This section includes instructions on some important maintenance tasks. You can perform some of these tasks with the tools provided — if you have basic mechanical skills.

Other tasks that are more difficult and require special tools are best performed by professionals. Wheel removal should normally be handled only by a Honda technician or other qualified mechanic; instructions are included in this manual only to assist in emergency service.

Some of the most important safety precautions follow. However, we cannot warn you of every conceivable hazard that can arise in performing maintenance. Only you can decide whether or not you should perform a given task.

⚠ WARNING

Failure to properly follow maintenance instructions and precautions can cause you to be seriously hurt or killed.

Always follow the procedures and precautions in this owner's manual.

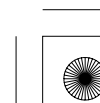
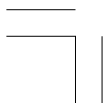



SAFETY PRECAUTIONS

- Make sure the engine is off before you begin any maintenance or repairs. This will help eliminate several potential hazards:

- * **Carbon monoxide poisoning from engine exhaust.**

- Be sure there is adequate ventilation whenever you operate the engine.

- * **Burns from hot parts.**

- Let the engine and exhaust system cool before touching.

- * **Injury from moving parts.**

- Do not run the engine unless instructed to do so.

- Read the instructions before you begin, and make sure you have the tools and skills required.
- To help prevent the motorcycle from falling over, park it on a firm, level surface, using the side stand or a maintenance stand to provide support.

- To reduce the possibility of a fire or explosion, be careful when working around petrol or batteries. Use only nonflammable solvent, not petrol, to clean parts. Keep cigarettes, sparks and flames away from the battery and all fuel-related parts.

Remember that your Honda dealer knows your motorcycle best and is fully equipped to maintain and repair it.

To ensure the best quality and reliability, use only new Honda Genuine Parts or their equivalents for repair and replacement.

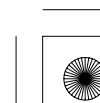



MAINTENANCE SCHEDULE

Perform the Pre-ride Inspection (page 52) at each scheduled maintenance period.

I: INSPECT AND CLEAN, ADJUST, LUBRICATE OR REPLACE IF NECESSARY

C: CLEAN R: REPLACE A: ADJUST L: LUBRICATE

The following items require some mechanical knowledge. Certain items (particularly those marked * and **) may require more technical information and tools. Consult your dealer.

* Should be serviced by your dealer, unless the owner has proper tools and service data and is mechanically qualified. Refer to the Official Honda Shop Manual.

** In the interest of safety, we recommend these items be serviced only by your dealer.

Honda recommends that your dealer should road test your motorcycle after each periodic maintenance is carried out.

NOTE: (1) At higher odometer readings, repeat at the frequency interval established here.

(2) Service more frequently when riding in unusually wet or dusty areas.

(3) Service more frequently when riding in rain or at full throttle.

(4) Service more frequently when riding OFF-ROAD.

(5) Replacement requires mechanical skill.

(6) Replace the PAIR air filter every 3 years or 24,000 km. Replacement requires mechanical skill.

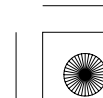
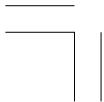



ITEMS	NOTE	PRE-RIDE CHECK (page 52)	ODOMETER READING (NOTE 1)				ANNUAL CHECK	REGULAR REPLACE	Refer to page
			× 1,000 km × 1,000 mi	1 0.6	4 2.5	8 5			
* FUEL LINE				I	I	I	I	—	
FUEL LEVEL		I						—	
* FUEL STRAINER SCREEN				C	C	C		—	
* THROTTLE OPERATION		I		I	I	I	I	84	
* AIR CLEANER (DK/IIDK type)	(NOTE 2)		EVERY 12,000 km (7,500 mi) R						—
* AIR CLEANER (Except DK/IIDK type)	(NOTE 2)		EVERY 16,000 km (10,000 mi) R						—
* AIR CLEANER SUB FILTER	(NOTE 2)			C	C	R		—	
CRANKCASE BREATHER	(NOTE 3)			C	C	C	C	77	
SPARK PLUG				I	R	I		82	
* VALVE CLEARANCE				I	I	I	I	—	
ENGINE OIL	(NOTE 4)	I		R	R	R	R	78	
* ENGINE OIL STRAINER SCREEN						C		—	
** ENGINE OIL CENTRIFUGAL FILTER						C		—	
* ENGINE IDLE SPEED				I	I	I	I	85	
* SECONDARY AIR SUPPLY SYSTEM (Except IIDK type)	(NOTE 6)					I	I	3 years	

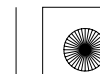

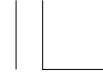

ITEMS	NOTE	PRE-RIDE CHECK (page 52)	ODOMETER READING (NOTE 1)				ANNUAL CHECK	REGULAR REPLACE	Refer to page
			× 1,000 km × 1,000 mi	1 0.6	4 2.5	8 5			
DRIVE CHAIN	(NOTE 4)	I	EVERY 1,000 km (600 mi) I, L						86
DRIVE CHAIN SLIDER				I	I	I			93
BRAKE FLUID (Except IIDK type)	(NOTE 5)	I		I	I	I	I	2 years	25
BRAKE SHOES WEAR (IIDK type)		I		I	I	I	I		104
BRAKE SHOES/PADS WEAR (Except IIDK type)		I		I	I	I	I		103, 104
BRAKE SYSTEM		I		I	I	I	I		24–30 103,104
BRAKELIGHT SWITCH				I	I	I	I		111
HEADLIGHT AIM				I	I	I	I		51
LIGHTS/HORN		I							–
CLUTCH SYSTEM		I		I	I	I	I		31
SIDE STAND (NZ ONLY)		I		I	I	I	I		96
SIDE STAND (EXCEPT NZ)				I	I	I	I		95
SUSPENSION				I	I	I	I		94
* NUTS, BOLTS, FASTENERS	(NOTE 4)			I		I	I		–
** WHEELS/TYRES	(NOTE 4)	I		I	I	I	I		–
** STEERING HEAD BEARINGS				I			I		–

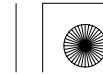

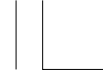

TOOL KIT

The tool kit (1) is in the tool box (2) behind the left side cover.

To open the tool box lid (3) insert the ignition key (4) into the tool box lid. Turn it counterclockwise, then open the tool box lid. Some roadside repairs, minor adjustments and parts replacement can be performed with the tools contained in the kit.

- 10 × 12 mm Open end wrench
- 14 × 17 mm Open end wrench
- No. 2 Phillips screwdriver
- No. 2 screwdriver
- Screwdriver handle
- 24 mm Box end wrench
- Extension bar
- Spark plug wrench
- Tool bag

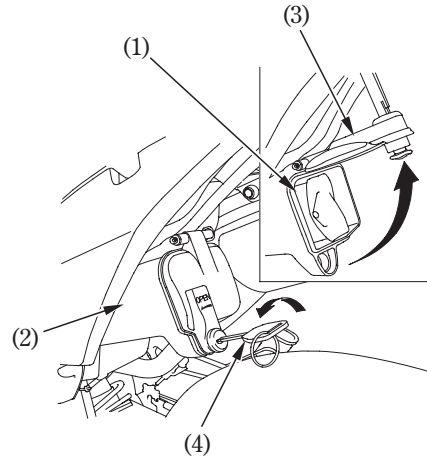

(1) Tool kit
(2) Tool box

(3) Tool box lid
(4) Ignition key

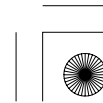
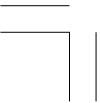



SERIAL NUMBERS

The frame and engine serial numbers are required when registering your motorcycle. They may also be required by your dealer when ordering replacement parts. Record the numbers here for your reference.

The frame number (1) is stamped on the right side of the steering head.

The engine number (2) is stamped on the left side of the crankcase.

FRAME NO. _____

ENGINE NO. _____

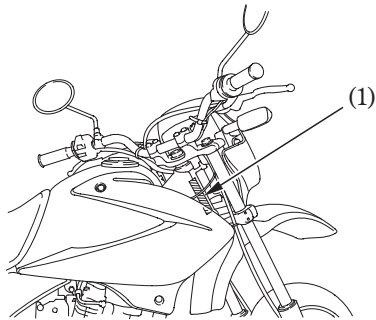

(1) Frame number

74

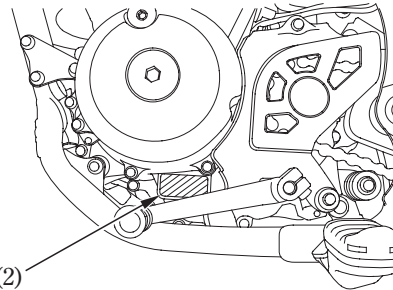

(2) Engine number

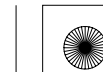



COLOUR LABEL

The colour label (1) is attached to the right side of the frame.

It is helpful when ordering replacement parts. Record the colour and code here for your reference.

COLOUR _____

CODE _____

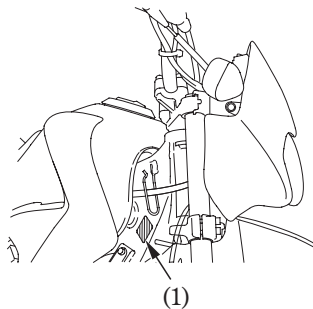

(1) Colour label

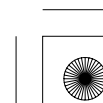
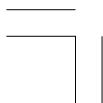



AIR CLEANER

Refer to the Safety Precautions on page 69 .

This motorcycle is equipped with a viscous type air cleaner element.
Air blow cleaning or any other cleaning can degrade the viscous element performance and cause the intake of dust.
Do not perform the maintenance.
Should be serviced by your dealer.

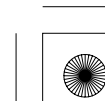
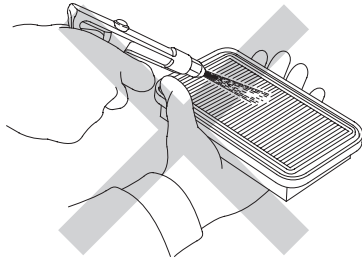



CRANKCASE BREATHER

Refer to the Safety Precautions on page 69 .

1. Remove the crankcase breather tube plug (1) from the tube and drain deposits into a suitable container.
2. Reinstall the crankcase breather tube plug.

Service more frequently when riding in rain, at full throttle, or after the motorcycle is washed or overturned. Service if the deposit level can be seen in the transparent section of the drain tube.

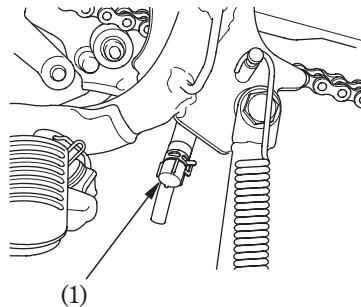

(1) Crankcase breather tube plug

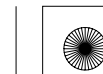



ENGINE OIL

Refer to the Safety Precautions on page 69 .

Oil Recommendation

API classification	SG or higher except oils labeled as energy conserving on the circular API service label
Viscosity	SAE 10W-30
JASO T 903 standard	MA

Suggested Oil
Honda "4-STROKE MOTORCYCLE OIL" or equivalent.

Your motorcycle does not need oil additives. Use the recommended oil.

Do not use oils with graphite or molybdenum additives. They may adversely affect clutch operation.

Do not use API SH or higher oils displaying a circular API "energy conserving" service label on the container. They may affect lubrication and clutch performance.

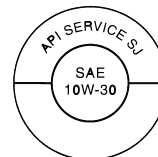

NOT RECOMMENDED

OK

Do not use non-detergent, vegetable, or castor based racing oils.

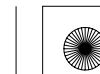



Viscosity:

Viscosity grade of engine oil should be based on average atmospheric temperature in your riding area. The following provides a guide to the selection of the proper grade or viscosity of oil to be used at various atmospheric temperatures.

JASO T 903 standard

The JASO T 903 standard is an index for engine oils for 4-stroke motorcycle engines. There are two classes: MA and MB. Oil conforming to the standard is labeled on the oil container. For example, the following label shows the MA classification.

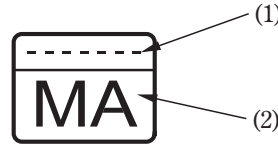
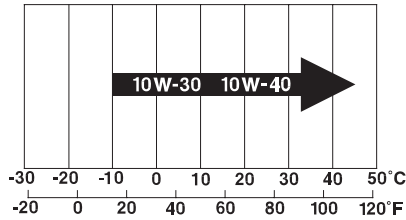

- (1) Oil code
- (2) Oil classification

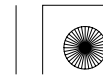



Engine Oil Change

Engine oil quality is the chief factor affecting engine service life. Change the engine oil as specified in the maintenance schedule (page 71).

When running in very dusty conditions, oil changes should be performed more frequently than specified in the maintenance schedule.

Please dispose of used engine oil in a manner that is compatible with the environment. We suggest you take it in a sealed container to your local recycling center or service station for reclamation. Do not throw it in the trash or pour it on the ground or down a drain.

Used engine oil may cause skin cancer if repeatedly left in contact with the skin for prolonged periods. Although this is unlikely unless you handle used oil on a daily basis, it is still advisable to thoroughly wash your hands with soap and water as soon as possible after handling used oil.

Changing the oil requires a torque wrench. If you do not have it and the necessary skill, we recommend that you have your dealer perform this service.

If a torque wrench is not used for this installation, see your dealer as soon as possible to verify proper assembly.

Change the engine oil with the engine at normal operating temperature and the motorcycle on its center stand to assure complete and rapid draining.

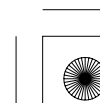
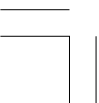



1. Place a drain pan under the crankcase.
2. To drain the oil, remove the oil fill cap/dipstick, oil drain bolt (1), and sealing washer (2).
3. Operate the kickstarter several times to aid in complete draining of the remaining oil.
4. Check that the sealing washer on the drain bolt is in good condition and install the bolt. Replace the sealing washer every other time the oil is changed, or each time if necessary.
Oil drain bolt torque:
30 N·m (3.1 kgf·m , 22 lbf·ft)
5. Fill the crankcase with the recommended grade oil; approximately:
1.0 ℓ (1.1 US qt , 0.9 Imp qt)
6. Install the oil fill cap/dipstick.
7. Start the engine and let it idle for 3–5 minutes.
8. 2–3 minutes after stopping the engine, check that the oil level is at the upper level mark on the oil fill cap/dipstick with the motorcycle on its center stand, level ground. Make sure there are no oil leaks.

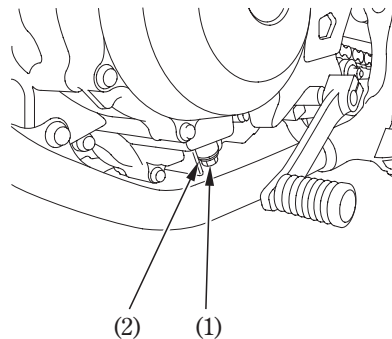

(1) Oil drain bolt

(2) Sealing washer

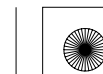



SPARK PLUG

Refer to the Safety Precautions on page 69 .

Recommended plugs:

Standard:

CPR7EA-9 (NGK)

For extended high speed riding:

CPR8EA-9 (NGK)

For most riding conditions this spark plug heat range number is satisfactory. However, if the motorcycle is going to be operated for extended periods at high speeds or near maximum power in hot climates, the spark plug should be changed to a colder heat range (a higher number).

NOTICE

Never use a spark plug with an improper heat range. Severe engine damage could result.

1. Clean any dirt from around the spark plug base.
2. Disconnect the spark plug cap (1) and remove the spark plug with the spark plug wrench (2) provided in the tool kit.

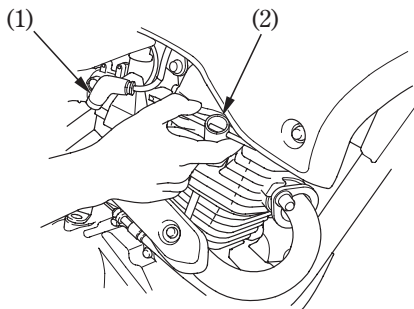

- (1) Spark plug cap
- (2) Spark plug wrench

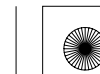



3. Inspect the electrodes and center porcelain for deposits, erosion or carbon fouling. If the erosion or deposit is heavy, replace the plug. Clean a carbon or wet-fouled plug with a plug cleaner, otherwise use a wire brush.
4. Check the spark plug gap (2) using a wire-type feeler gauge. If adjustment is necessary, bend the side electrode (3) carefully.
The gap should be:
0.8–0.9 mm (0.03–0.04 in)
5. Make sure the plug washer is in good condition.
6. With the plug washer attached, thread the spark plug in by hand to prevent cross-threading.
7. Tighten each spark plug:
 - If the old plug is good:
1/8 turn after it seats.
 - If installing a new plug, tighten it twice to prevent loosening:
 - a) First, tighten the plug:
NGK: 1/2 turn after it seats.
Then loosen the plug.
 - b) Next, tighten the plug again:
 - c) 1/8 turn after it seats.

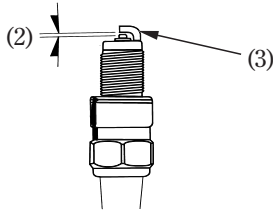

- (2) Spark plug gap
- (3) Side electrode

NOTICE

An improperly tightened spark plug can damage the engine. If a plug is too loose, a piston may be damaged. If a plug is too tight, the threads may be damaged.

8. Reinstall the spark plug cap. Take care to avoid pinching any cables or wires.

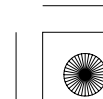
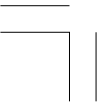



THROTTLE OPERATION

Refer to the Safety Precautions on page 69 .

1. Check for smooth rotation of the throttle grip from the fully open to the fully closed position at both full steering positions.
2. Measure the throttle grip freeplay at the throttle grip flange.
The standard freeplay should be approximately:
2 – 6 mm (0.1 – 0.2 in)

To adjust the freeplay, slide the throttle cable boot (1), then loosen the lock nut (2) and turn the adjuster (3).
After adjustment, tighten the lock nut and return the throttle cable boot securely.

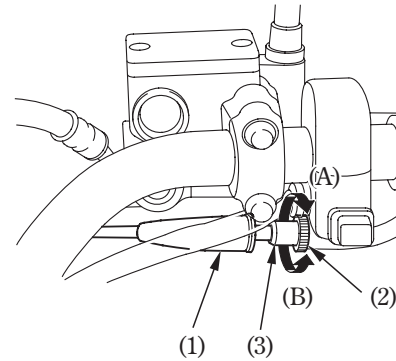

- | | |
|-------------------------|-----------------------|
| (1) Throttle cable boot | (A) Increase freeplay |
| (2) Lock nut | (B) Decrease freeplay |
| (3) Adjuster | |

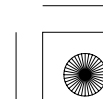



IDLE SPEED

Refer to the Safety Precautions on page 69 .

Idle Speed:

The engine must be at normal operating temperature for accurate idle speed adjustment. 10 minutes of stop-and-go riding is sufficient.

Do not attempt to compensate for faults in other systems by adjusting idle speed. See your dealer for regularly scheduled carburetor adjustments.

1. Warm up the engine and hold the motorcycle upright. Shift to neutral.
2. Connect a tachometer to the engine.
3. Adjust idle speed with the throttle stop screw (1).

Idle speed (In neutral):

$1,500 \pm 100 \text{ min}^{-1} (\text{rpm})$

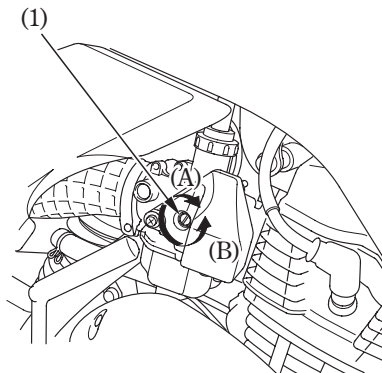

(1) Throttle stop screw

(A) Increase rpm

(B) Decrease rpm

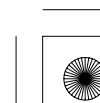
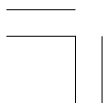



DRIVE CHAIN

Refer to the Safety Precautions on page 69 .

The service life of the drive chain (1) is dependent upon proper lubrication and adjustment. Poor maintenance can cause premature wear or damage to the drive chain and sprockets.

The drive chain should be checked, adjusted and lubricated as part of the Pre-ride Inspection (page 52). Under severe usage, or when the motorcycle is ridden in unusually dusty or muddy areas, more frequent maintenance will be necessary.

Inspection:

1. Turn the engine off, raise the rear wheel off the ground by placing a support under the engine, and shift the transmission into neutral.
2. Check slack in the lower drive chain run midway between the sprockets. Drive chain slack should be adjusted to allow the following vertical movement by hand:

20–30 mm (0.8–1.2 in)

3. Rotate the rear wheel. Stop. Check the drive chain slack. Repeat this procedure several times. Drive chain slack should remain constant. If the chain is slack only in certain sections, some links are kinked and binding. Binding and kinking can frequently be eliminated by lubrication.

NOTICE

Excessive chain slack may allow the drive chain to damage the engine cases.

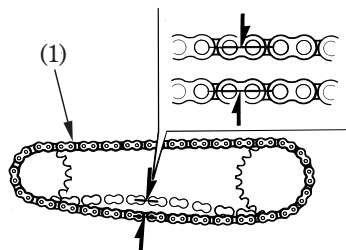

(1) Drive chain





4. Rotate the rear wheel slowly and inspect the drive chain and sprockets for any of the following conditions:

DRIVE CHAIN

- *Damaged Rollers
- *Loose Pins
- *Dry or Rusted Links
- *Kinked or Binding Links
- *Excessive Wear
- *Improper Adjustment
- *Damaged or Missing O-rings

SPROCKETS

- *Excessively Worn Teeth
- *Broken or Damaged Teeth

A drive chain with damaged rollers, loose pins, or missing O-rings must be replaced. A chain which appears dry, or shows signs of rust, requires supplementary lubrication. Kinked or binding links should be thoroughly lubricated and worked free. If links cannot be freed, the chain must be replaced.

Damaged Sprocket
Teeth

REPLACE

Worn Sprocket
Teeth

REPLACE

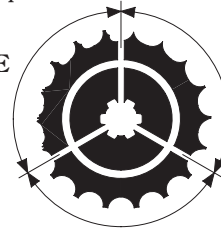

Normal Sprocket Teeth

GOOD

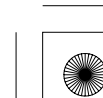
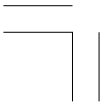



Adjustment:

Drive chain slack should be checked and adjusted, if necessary, every 1,000 km (600 miles). When operated at sustained high speeds or under conditions of frequent rapid acceleration, the chain may require more frequent adjustment.

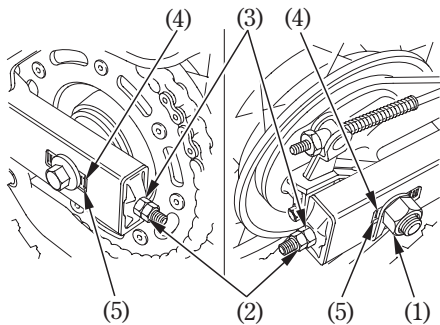

- (1) Rear axle nut
- (2) Drive chain lock nuts
- (3) Drive chain adjusting nuts
- (4) Index marks
- (5) Rear edge of adjusting slots

If the drive chain requires adjustment, the procedure is as follows:

1. Place the motorcycle on its side stand on a firm, level surface with the transmission in neutral and the ignition switch OFF.
2. Loosen the rear axle nut (1).
3. Loosen the drive chain lock nuts (2) on both sides of the swingarm.
4. Turn the drive chain adjusting nuts (3) clockwise to tighten the drive chain, or counterclockwise to provide more drive chain slack. Adjust the drive chain slack at a point midway between the drive sprocket and driven sprocket. Roll the motorcycle forward. Stop and place it on its side stand. Recheck drive chain slack.

Drive chain slack should be:
20 – 30 mm (0.8 – 1.2 in)

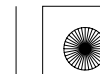



5. Align the drive chain adjuster index marks (4) with the rear edge of the adjusting slots (5). Both index marks should correspond. If the axle is misaligned, turn the left or right drive chain adjusting nut until the index marks correspond on the rear edge of the adjusting slots and recheck drive chain slack.
7. Tighten the drive chain adjusting nuts lightly, then tighten the drive chain lock nuts by holding the drive chain adjusting nuts with a spanner.
8. Recheck drive chain slack.
9. Rear brake pedal freeplay is affected when repositioning the rear wheel to adjust drive chain slack. Check rear brake pedal freeplay and adjust as necessary (page 29).

If the drive chain slack is excessive when the rear axle is moved to the furthest limit of adjustment, the drive chain is worn and must be replaced.

6. Tighten the rear axle nut to the specified torque.
Rear axle nut torque:
93 N·m (9.5 kgf·m , 69 lbf·ft)

If a torque wrench is not used for this installation, see your dealer as soon as possible to verify proper assembly.

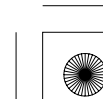



Wear Inspection:

Check the drive chain wear label (6) when adjusting the drive chain. If the red zone (7) on the drive chain wear label align with the arrow mark (8) after the drive chain has been adjusted to the proper drive chain slack, the drive chain is excessively worn and must be replaced.

The proper drive chain slack is:

20–30 mm (0.8–1.2 in)

Damage to the bottom part of the frame may be caused by excessive drive chain slack of more than:

60 mm (2.4 in)

Drive chain:

CHOHO 428HO–130LE

If necessary, have the drive chain replaced by your dealer.

(III LA, CO, ILA type)

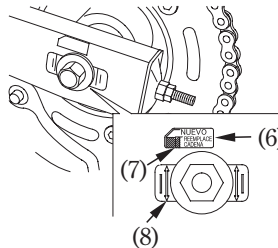

(DK, NZ, IIDK type)

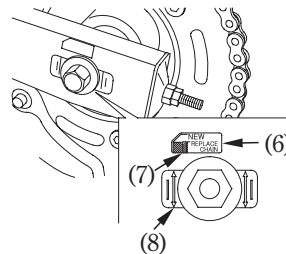

(6) Drive chain wear label (8) Arrow mark
(7) Red zone

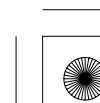
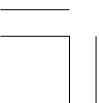



(IIDK type)

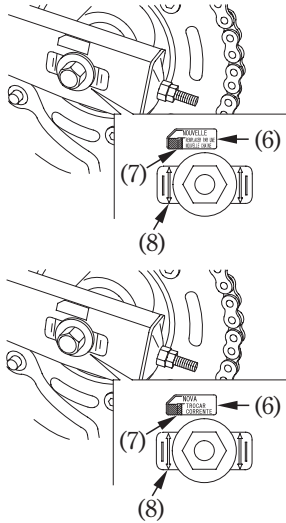

- (6) Drive chain wear label (8) Arrow mark
(7) Red zone

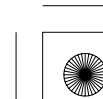
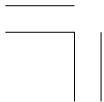



Lubrication and Cleaning:

Lubricate every 1,000 km (600 miles) or sooner if chain appears dry.

After inspecting the slack, clean the chain and sprockets while rotating the rear wheel. Use dry cloth with chain cleaner designed specifically for O-ring chains, or neutral detergent. Use a soft brush if the chain is dirty.

After cleaning, wipe dry and lubricate with drive chain lubricant designed specifically for O-ring chains. If not available, use SAE 80 or 90 gear oil.

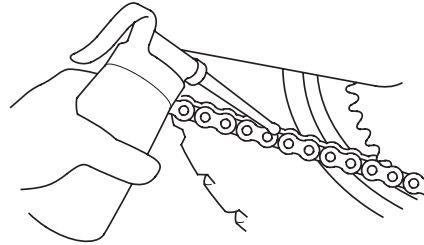

Do not use a steam cleaner, a high pressure cleaner, a wire brush, volatile solvent such as gasoline and benzene, abrasive cleaner, chain cleaner or lubricant not designed specifically for O-ring chains as these can damage the rubber O-ring seals.

Avoid getting lubricant on the brakes or tyres. Avoid applying excess chain lubricant to prevent spray onto your clothes and the motorcycle.

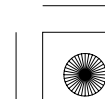
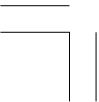



DRIVE CHAIN SLIDER

Refer to the Safety Precautions on page 69 .

Check the drive chain slider (1) for wear. When the thickness of the drive chain slider reaches the wear limit point (2), the drive chain slider must be replaced. See your dealer.

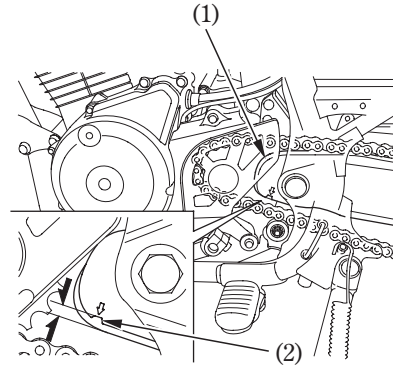

(1) Drive chain slider (2) Wear limit point

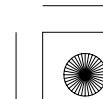
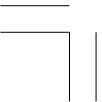



FRONT AND REAR SUSPENSION INSPECTION

Refer to the Safety Precautions on page 69 .

1. Check the fork assembly by locking the front brake and pumping the fork up and down vigorously. Suspension action should be smooth and there must be no oil leakage.
2. Swingarm bearings should be checked by pushing hard against the side of the rear wheel while the motorcycle is on a support block. Freeplay indicates worn bearings.
3. Carefully inspect all front and rear suspension fasteners for tightness.

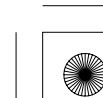



SIDE STAND

Refer to the Safety Precautions on page 69 .

(except NZ type)

Check the side stand spring (1) for damage and loss of tension, and the side stand assembly for freedom of movement. If the side stand is squeaky or stiff, clean the pivot area and lubricate the pivot bolt with clean engine oil.

Check the rubber pad for deterioration and wear. Replace if wear extends to the wear line (See (2) in the picture). Check the side stand assembly for freedom of movement. If parts must be replaced, please contact your dealer.

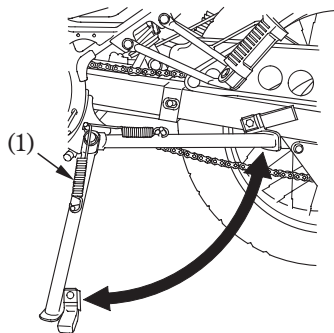

(1) Side stand spring

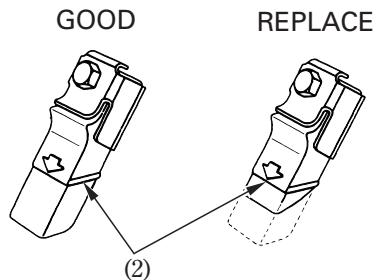

(2) Wear line

Replace if wear extends to any point of the wear line.

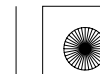



(NZ type only)

Perform the following maintenance in accordance with the maintenance schedule.

Functional Check:

- Check the side stand spring (1) for damage or loss of tension and the side stand assembly for freedom of movement.
- Check the side stand ignition cut-off system:
 1. Sit astride the motorcycle; put the side stand up and the transmission in neutral.
 2. Start the engine and with the clutch lever pulled in, shift the transmission into gear.
 3. Lower the side stand. The engine should stop as you put the side stand down.

If the side stand system does not operate as described, see your dealer for service.

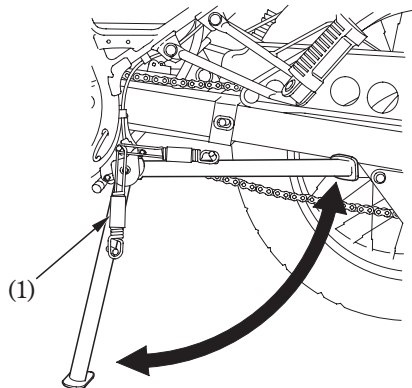

(1) Side stand spring

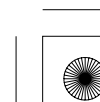
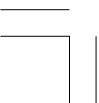



WHEEL REMOVAL

Refer to the Safety Precautions on page 69 .

Front Wheel Removal (XR125LK/LEK)

1. Raise the front wheel off the ground by placing a support block under the engine.
2. Disconnect the speedometer cable (1) from the speedometer gearbox by removing the speedometer cable set screw (2).
3. Remove the rubber cap (3).
4. Remove the front axle nut (4).
5. Remove the front axle shaft (5), front wheel and side collar.

Do not depress the brake lever when the wheel is off the motorcycle. The caliper pistons will be forced out of the cylinders with subsequent loss of brake fluid. If this occurs, servicing of the brake system will be necessary. See your dealer for this service.

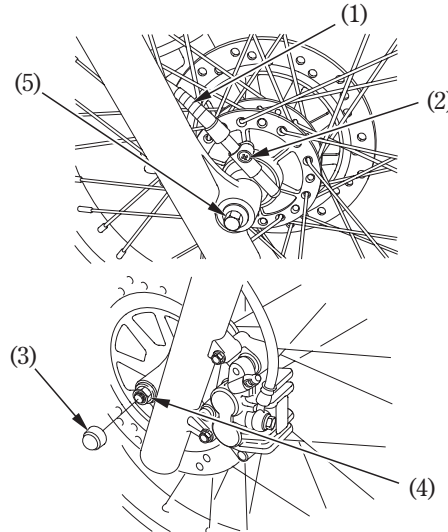

- | | |
|---------------------------------|----------------------|
| (1) Speedometer cable | (4) Front axle nut |
| (2) Speedometer cable set screw | (5) Front axle shaft |
| (3) Rubber cap | |





Front Wheel Installation (XR125LK/LEK)

- Reverse the removal procedure.
- Install the side collar into the left side wheel hub.
- Position the front wheel between the fork legs and insert the front axle shaft from the right side, through the right fork leg and wheel hub.

Make sure that the lug (6) on the right fork leg is located in the slot (7) of the speedometer gear box (8).

When installing the wheel, carefully fit the brake disc between the brake pads to avoid damaging the pads.

- Tighten the front axle nut to the specified torque:
44 N·m (4.5 kgf·m , 33 lbf·ft)
- After installing the wheel, apply the brake several times and then check if the wheel rotates freely. Recheck the wheel if the brake drags or if the wheel does not rotate freely.

If a torque wrench is not used for installation, see your dealer as soon as possible to verify proper assembly. Improper assembly may lead to loss of braking capacity.

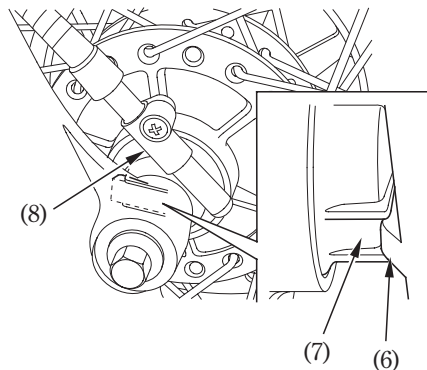

(6) Lug
(7) Slot

(8) Speedometer gear box

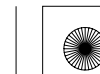



Front Wheel Removal (XL125LK)

1. Raise the front wheel off the ground by placing a support block under the engine.
2. Remove the speedometer cable (1) by pushing the tab (2).

3. Remove the front brake adjusting nut (3) and remove the front brake cable (4) from the brake arm (5).
4. Remove the front axle nut (6).
5. Remove the front axle shaft (7), front wheel and collar.

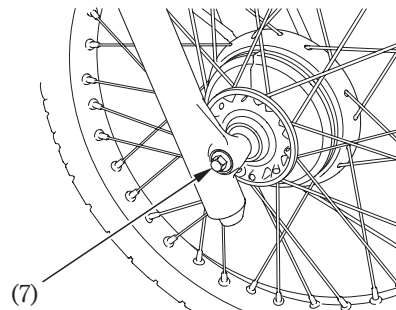
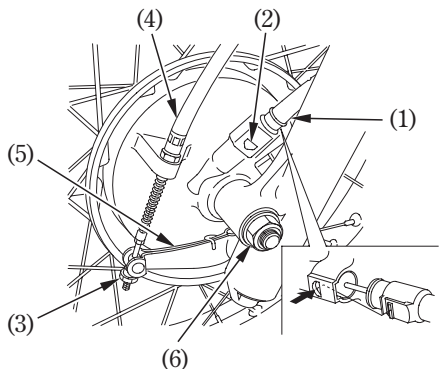

- | | |
|-------------------------------|-----------------------|
| (1) Speedometer cable | (4) Front brake cable |
| (2) Tab | (5) Brake arm |
| (3) Front brake adjusting nut | (6) Front axle nut |

- (7) Front axle shaft

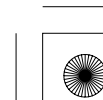
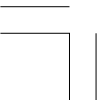



Front Wheel Installation (XL125LK)

- Reverse the removal procedure.
- Install the side collar into the right side wheel hub.
- Position the wheel between the fork legs and insert the front axle shaft from the right side, through the right fork leg and wheel hub.
- Make sure that the lug (8) on the left fork leg is located in the brake panel.
- Tighten the front axle nut to specified torque.

Front axle nut torque:

44 N·m (4.5 kgf·m , 33 lbf·ft)

- Install the brake cable and front brake adjusting nut.
- Adjust the front brake (pages 27 – 28).
- After installing the wheel, apply the brake several times and then check if the wheel rotates freely. Recheck the wheel if the brake drags or if the wheel does not rotate freely.
- Install the speedometer cable securely.

If a torque wrench is not used for installation, see your dealer as soon as possible to verify proper assembly. Improper assembly may lead to loss of braking capacity.

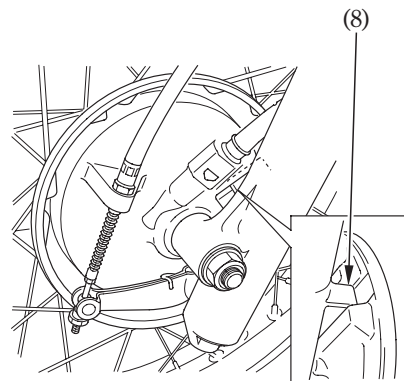

(8) Lug

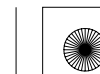



Rear Wheel Removal

Refer to the Safety Precautions on page 69 .

1. Raise the rear wheel off the ground by placing a support block under the engine.
2. Remove the rear brake adjusting nut (1).
3. Disconnect the brake rod (2) from the brake arm (3) by pushing down on the rear brake pedal.

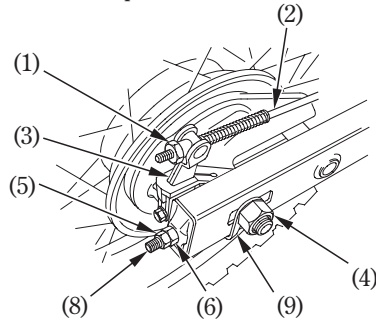

- | | |
|------------------------------|---------------------------|
| (1) Rear brake adjusting nut | (4) Rear axle nut |
| (2) Brake rod | (5) Drive chain lock nuts |
| (3) Brake arm | |

4. Remove the rear axle nut (4) and loosen the lock nuts (5) and drive chain adjusting nuts (6).
5. Remove the rear axle shaft (7), drive chain adjusters (8), axle washer (9), and side collar, then remove the drive chain (10) from the driven sprocket by pushing the rear wheel forward.
6. Remove the rear wheel from the motorcycle.

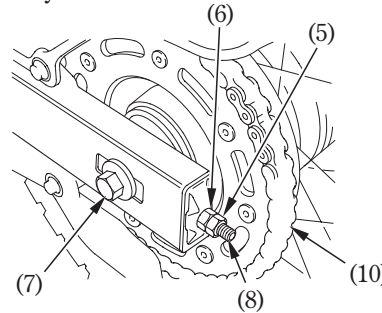

- | | |
|--------------------------------|---------------------------|
| (6) Drive chain adjusting nuts | (8) Drive chain adjusters |
| (7) Rear axle shaft | (9) Axle washer |
| | (10) Drive chain |





Rear Wheel Installation

- Reverse the removal procedure.
- Install the side collar into the left side wheel hub.
- Make sure that the lug (11) on the swingarm (12) is located in the slot (13) in the brake panel (14).
- Tighten the rear axle nut to the specified torque:
93 N·m (9.5 kgf·m , 69 lbf·ft)
- Adjust the drive chain (page 88) and rear brake pedal freeplay (page 29).
- After installing the wheel, apply the brakes several times, and check for free wheel rotation when released.

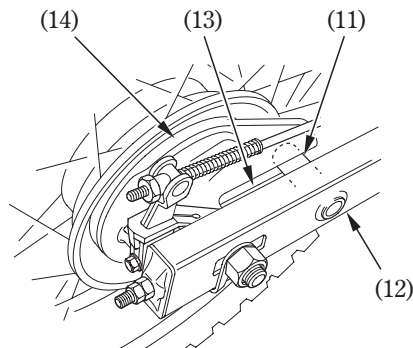

(11) Lug
(12) Swingarm
(13) Slot
(14) Brake panel

If a torque wrench is not used for installation, see your dealer as soon as possible to verify proper assembly. Improper assembly may lead to loss of braking capacity.

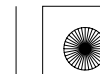



BRAKE PAD WEAR (XR125LK/LEK)

Refer to the Safety Precautions on page 69 .

Brake pad wear depends upon the severity of usage, the type of riding, and road conditions. (Generally, the pads will wear faster on wet and dirty roads.) Inspect the pads at each regular maintenance interval (page 72).

Front Brake

Check the wear indicator grooves (1) in each pad.

If either pad is worn to the bottom of the grooves, replace both pads as a set. See your dealer for this service.

<FRONT BRAKE>

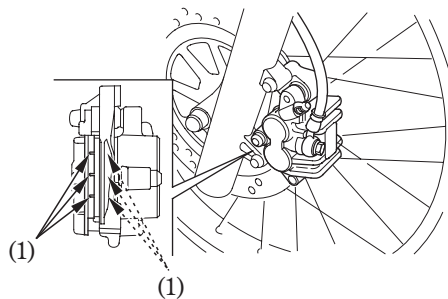

(1) Wear indicator grooves

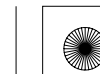



BRAKE SHOE WEAR

Refer to the Safety Precautions on page 69 .

(XL125LK)

The front and rear brakes are equipped with brake wear indicators.

(XR125LK/LEK)

The rear brake is equipped with a brake wear indicator.

When the brake is applied, an arrow (1) attached to the brake arm (2) moves toward a reference mark (3) on the brake panel (4). If the arrow aligns with the reference mark on full application of the brake, the brake shoes must be replaced. See your dealer for this service.

When the brake service is necessary, see your dealer. Use only Honda Genuine Parts or its equivalent.

< FRONT BRAKE > (XL125LK)

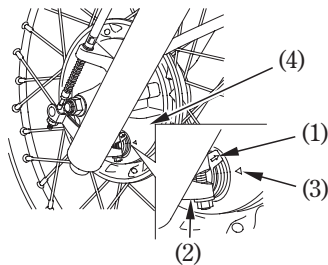

< REAR BRAKE >

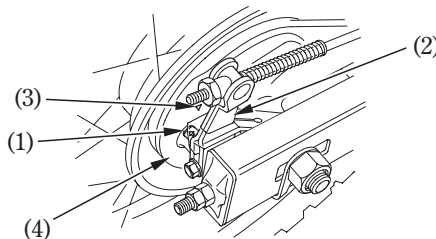

- (1) Arrow
- (2) Brake arm
- (3) Reference mark
- (4) Brake panel

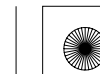



BATTERY

Refer to the Safety Precautions on page 69 .

It is not necessary to check the battery electrolyte level or add distilled water as the battery is a maintenance-free (sealed) type. If your battery seems weak and/or is leaking electrolyte (causing hard starting or other electrical troubles), contact your dealer.

NOTICE

Your battery is a maintenance-free type and can be permanently damaged if the cap strip is removed.

⚠ WARNING

The battery gives off explosive hydrogen gas during normal operation.

A spark or flame can cause the battery to explode with enough force to kill or seriously hurt you.

Wear protective clothing and a face shield, or have a skilled mechanic do the battery maintenance.

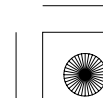
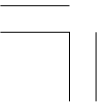



Removal:

The battery (1) is behind the left side cover.

1. Make sure the ignition switch is OFF.
2. Remove the left side cover (page 48).
3. Remove the battery holder (2) by removing the bolt (3).
4. Disconnect the negative (-) terminal lead (4) from the battery first, then disconnect the positive (+) terminal lead (5).
5. Pull out the battery.

(XR125LEK)

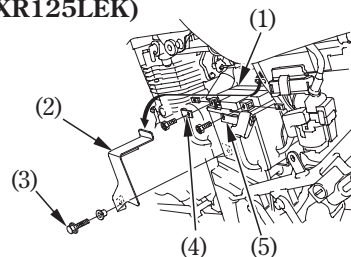

(XR125LK, XL125LK)

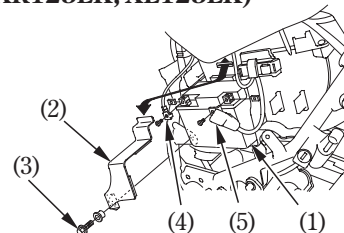

Installation:

1. Reinstall in the reverse order of removal. Be sure to connect the positive (+) terminal first, then the negative (-) terminal.
2. Check all bolts and other fasteners are secure.

- | | |
|--------------------|--------------------------------|
| (1) Battery | (4) Negative (-) terminal lead |
| (2) Battery holder | (5) Positive (+) terminal lead |
| (3) Bolt | |

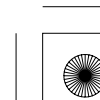
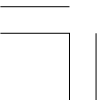



FUSE REPLACEMENT

Refer to the Safety Precautions on page 69 .

When frequent fuse failure occurs, it usually indicates a short circuit or an overload in the electrical system. See your dealer for repair.

NOTICE

Never use a fuse with a different rating from that specified. Serious damage to the electrical system or a fire may result, causing a dangerous loss of lights or engine power.

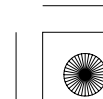
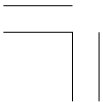
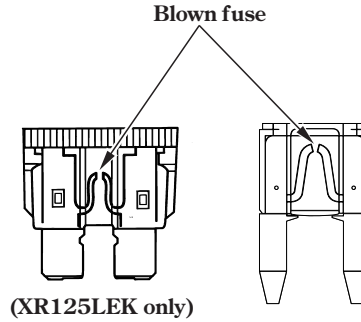

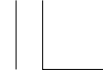

Sub Fuse:

The fuse box (1) is located behind the left side cover.

The specified fuse is:

10 A

1. Make sure the ignition switch is OFF.
2. Remove the left side cover (page 48).
3. Open the fuse box cover (2).
4. Pull out the old fuse. If the fuse is blown, install a spare fuse. The spare fuses (3) are located in the fuse box and fuse box holder (4).
5. Close the fuse box cover and install the left side cover.

(XR125LEK)

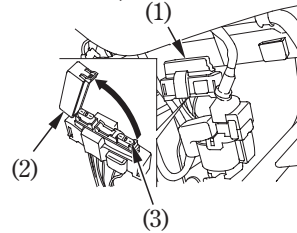

(XR125LK, XL125LK)

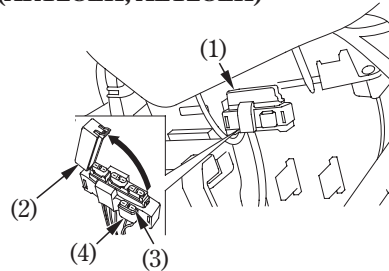

- | | |
|--------------------|---------------------|
| (1) Fuse box | (3) Spare fuse |
| (2) Fuse box cover | (4) Fuse box holder |

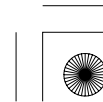
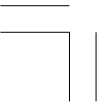



**Main Fuse:
(XR125LEK)**

The main fuse (1) is located behind the left side cover.

The specified fuse is:

15 A

1. Make sure the ignition switch is OFF.
2. Remove the left side cover (page 48).
3. Disconnect the wire connector (2) of the starter magnetic switch (3).
4. Pull out the old fuse. If the fuse is blown, install a spare fuse.

The spare main fuse (4) is located upper right side of the starter magnetic switch.

5. Reconnect the wire connector and install the left side cover.

(XR125LEK)

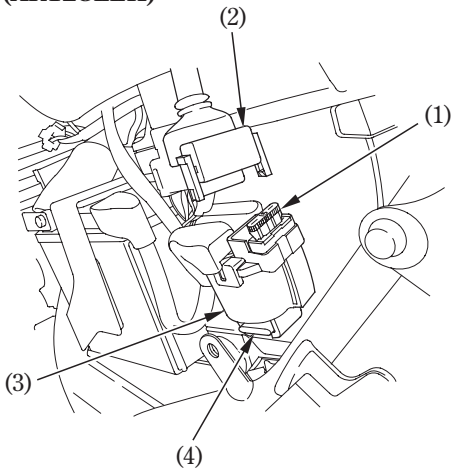

- (1) Main fuse
- (2) Wire connector
- (3) Starter magnetic switch
- (4) Spare main fuse

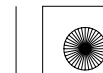



(XR125LK, XL125LK)

The main fuse (1) is located in the fuse box (2).

The fuse box is near the battery.

The specified fuse is:

15 A

1. Make sure the ignition switch is OFF.
2. Remove the left side cover (page 48).
3. Open the fuse box cover (3).
4. Pull out the old fuse. If the fuse is blown, install a spare fuse.

The spare main fuse (4) is located in the fuse box.

5. Close the main fuse box cover and install the left side cover.

(XR125LK, XL125LK)

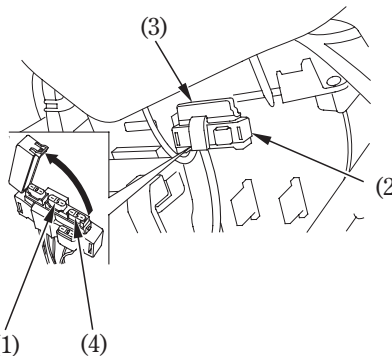

(1) Main fuse
(2) Fuse box

(3) Fuse box cover
(4) Spare main fuse

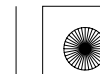



BRAKELIGHT SWITCH ADJUSTMENT

Refer to the Safety Precautions on page 69 .

Check the operation of the brakelight switch (1) at the right side behind the engine from time to time.

Adjustment is done by turning the adjusting nut (2). Turn the nut in the direction (A) if the switch operates too late and in direction (B) if the switch operates too soon.

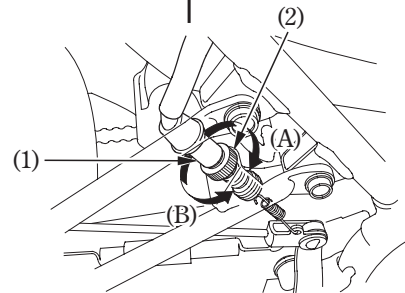
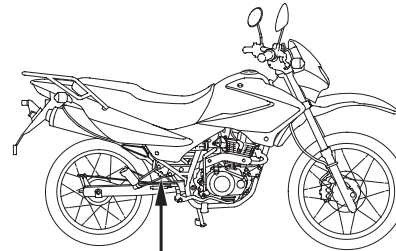

(1) Brakelight switch

(2) Adjusting nut

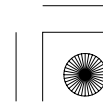
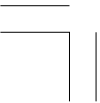



BULB REPLACEMENT

Refer to the Safety Precautions on page 69 .

The light bulb becomes very hot while the light is ON, and remains hot for a while after it is turned OFF. Be sure to let it cool down before servicing.

- Be sure to turn the ignition switch OFF when replacing the bulb.
- Do not use bulbs other than those specified.
- After installing a new bulb, check that the light operates properly.



Headlight Bulb

1. Remove the bolts (1).
2. Loosen the headlight aim vertical screw (2), then remove the headlight case (3).

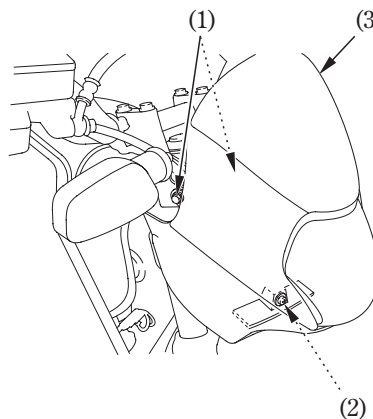

- (1) Bolts
- (2) Headlight aim vertical screw
- (3) Headlight case

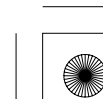



3. Pull back the rubber dust cover (4).
4. Remove the socket (5) while pressing down on the pin (6).
5. Slightly press the bulb (7) and turn it counterclockwise.
6. Install a new bulb in the reverse order of removal.
7. Install the removed parts in reverse order of removal.

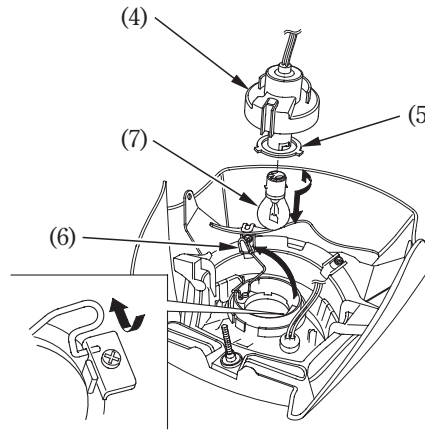

(4) Rubber dust cover
(5) Socket

(6) Pin
(7) Bulb

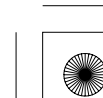
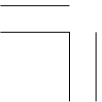



Position Light Bulb

1. Remove the headlight case (page 112).
2. Pull out the socket (1).
3. Slightly press the bulb (2) and turn it counterclockwise.
4. Install a new bulb in the reverse order of removal.
5. Install the removed parts in reverse order of removal.

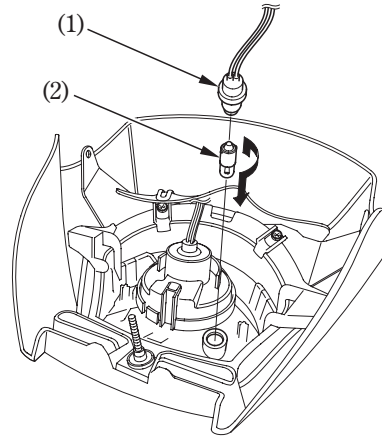

- (1) Socket
(2) Bulb

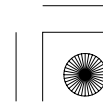
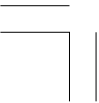



Brake/Tail Light Bulb

1. Remove the screws (1).
2. Remove the taillight lens (2).
3. Slightly press the bulb (3) and turn it counterclockwise.
4. Install a new bulb in the reverse order of removal.

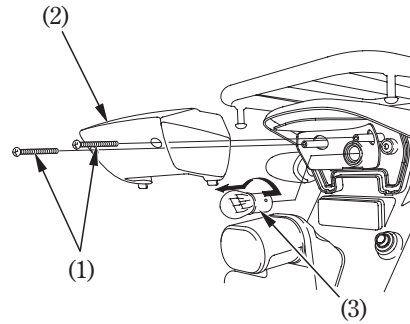

- (1) Screws
- (2) Taillight lens
- (3) Bulb

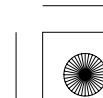
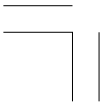



Front/Rear Turn Signal Bulb (XR125LK/LEK)

1. Remove the turn signal lens (1) by removing the screw (2).
2. Remove the socket (3) by turning it counterclockwise.

3. Pull out the bulb (4) without turning.
4. Install a new bulb in the reverse order of removal.
5. Install the removed parts in the reverse order of removal.

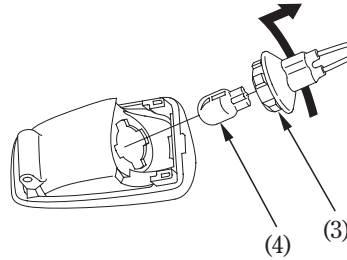
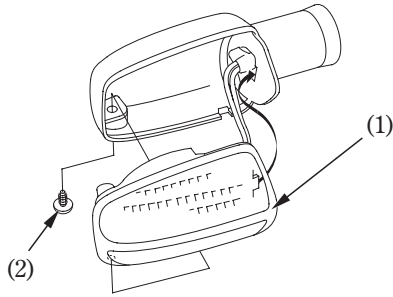

(1) Turn signal lens

(2) Screw

(3) Socket

(4) Bulb

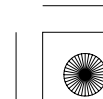



(XL125LK)

1. Remove the turn signal lens (1) by removing the screw (2).
2. Remove the bulb (3) by pressing in and turning counterclockwise.
3. Install a new bulb in the reverse order of removal.

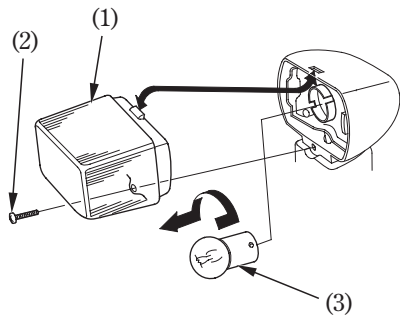

(1) Turn signal lens
(2) Screw

(3) Bulb

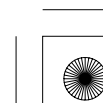
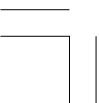



License Light Bulb (XR125LK/LEK)

1. Remove the nuts A (1), washers and license plate bracket (2).
2. Remove the nuts B (3), license light cover (4) and license light lens (5).
3. Slightly press the bulb (6) and turn it counterclockwise.
4. Install a new bulb in the reverse order of removal.
5. Install the removed parts in the reverse order of removal.

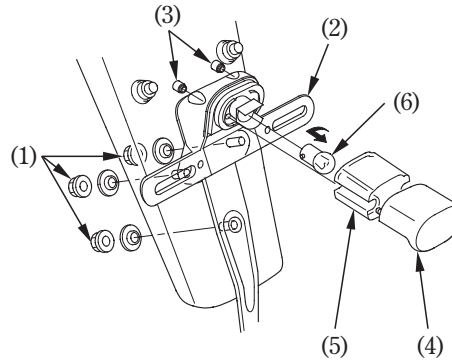

- | | |
|---------------------------|-------------------------|
| (1) Nuts A | (4) License light cover |
| (2) License plate bracket | (5) License light lens |
| (3) Nuts B | (6) Bulb |

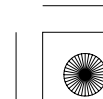



CLEANING

Clean your motorcycle regularly to protect the surface finishes and inspect for damage, wear, and oil or brake fluid leakage.

Avoid cleaning products that are not specifically designed for motorcycle or automobile surfaces.

They may contain harsh detergents or chemical solvents that could damage the metal, paint, and plastic on your motorcycle.

If your motorcycle is still warm from recent operation, give the engine and exhaust system time to cool off.

We recommend avoiding the use of high pressure water spray (typical in coin-operated car washes).

NOTICE

High pressure water (or air) can damage certain parts of the motorcycle.

Washing the Motorcycle

1. Rinse the motorcycle thoroughly with cool water to remove loose dirt.
2. Clean the motorcycle with a sponge or soft cloth using cool water.
Avoid directing water to muffler outlets and electrical parts.
3. Clean the plastic parts using a cloth or sponge dampened with a solution of mild detergent and water. Rub the soiled area gently rinsing it frequently with fresh water.
Take care to keep brake fluid or chemical solvents off the motorcycle.
They will damage the plastic and painted surfaces.
4. After cleaning, rinse the motorcycle thoroughly with plenty of clean water. Strong detergent residue can corrode alloy parts.
5. Dry the motorcycle, start the engine, and let it run for several minutes.

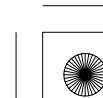
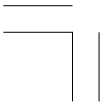



6. Test the brakes before riding the motorcycle. Several applications may be necessary to restore normal braking performance.
7. Lubricate the drive chain immediately after washing and drying the motorcycle.

Braking efficiency may be temporarily impaired immediately after washing the motorcycle.
Anticipate longer stopping distance to avoid a possible accident.

Finishing Touches

After washing your motorcycle, consider using a commercially-available spray cleaner/polish or quality liquid or paste wax to finish the job. Use only a non-abrasive polish or wax made specifically for motorcycles or automobiles. Apply the polish or wax according to the instructions on the container.

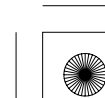



Removing Road Salt

Road Salt used on roads during winter and salt from seawater causes rust.

Wash your motorcycle as follows after it has run through salty water or on roads treated with Road Salt.

1. Clean the motorcycle using cool water (page 119).

Do not use warm water.

This worsens the effect of the salt.

2. Dry the motorcycle and make sure the metal is protected with the wax.

Exhaust Pipe and Muffler Maintenance

When the exhaust pipe and muffler are painted, do not use a commercially available abrasive kitchen cleaning compound. Use a neutral detergent to clean the painted surface on the exhaust pipe and muffler. If you are not sure if your exhaust pipe and muffler are painted, contact your dealer.

Clean the Seat

Due to the top coat design, the seat surface tends to catch and trap dirt or dust in its texture.

Using plenty of water, clean the seat with a sponge and mild detergent.

After washing, dry with a soft, clean cloth.

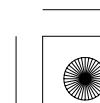
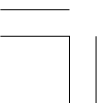



STORAGE GUIDE

Extended storage, such as for winter, requires that you take certain steps to reduce the effects of deterioration from non-use of the motorcycle. In addition, necessary repairs should be made BEFORE storing the motorcycle; otherwise, these repairs may be forgotten by the time the motorcycle is removed from storage.

STORAGE

1. Change the engine oil and filter.
2. Empty the fuel tank into an approved petrol container using a commercially available hand siphon or an equivalent method. Spray the inside of the tank with an aerosol rust-inhibiting oil.
Reinstall the fuel fill cap on the tank.

To assure proper performance after storage lasting more than one month, it is important to drain the carburetor.

WARNING

Petrol is highly flammable and explosive. You can be burned or seriously injured when handling fuel.

- Stop the engine and keep heat, sparks, and flame away.
- Refuel only outdoors.
- Wipe up spills immediately.

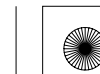



3. To prevent rusting in the cylinder, perform the following:
- Remove the spark plug cap from the spark plug. Using tape or string, secure the cap to any convenient plastic body part so that it is positioned away from the spark plug.
 - Remove the spark plug from the engine and store it in a safe place. Do not connect the spark plug to the spark plug cap.
 - Pour a tablespoon (15–20 cm³) of clean engine oil into the cylinder and cover the spark plug hole with a piece of cloth.
 - Crank the engine several times to distribute the oil.
 - Reinstall the spark plug and spark plug cap.
4. Remove the battery. Store in an area protected from freezing temperatures and direct sunlight.
Slow charge the battery once a month.
5. Wash and dry the motorcycle. Wax all painted surfaces. Coat chrome with rustinhibiting oil.
6. Lubricate the drive chain (page 92).
7. Inflate the tyres to their recommended pressures. Place the motorcycle on blocks to raise both tyres off the ground.
8. Cover the motorcycle (don't use plastic or other coated materials) and store in an unheated area, free of dampness with a minimum of daily temperature variation. Do not store the motorcycle in direct sunlight.

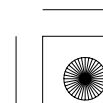
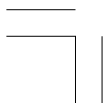



REMOVAL FROM STORAGE

1. Uncover and clean the motorcycle.
Change the engine oil if more than 4 months have passed since the start of storage.
2. Charge the battery as required. Install the battery.
3. Drain any excess aerosol rust-inhibiting oil from the fuel tank. Fill the fuel tank with fresh petrol.
4. Perform all Pre-ride Inspection checks (page 52).
Test ride the motorcycle at low speeds in a safe riding area away from traffic.

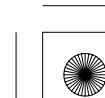
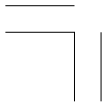



TAKING CARE OF THE UNEXPECTED

IF YOU CRASH

Personal safety is your first priority after a crash. If you or anyone else has been injured, take time to assess the severity of the injuries and whether it is safe to continue riding. Call for emergency assistance if needed. Also follow applicable laws and regulations if another person or vehicle is involved in the crash.

If you decide that you are capable of riding safely, first evaluate the condition of your motorcycle. If the engine is still running, turn it off and look it over carefully; inspect it for fluid leaks, check the tightness of critical nuts and bolts, and secure such parts as the handlebar, control levers, brakes, and wheels.

If there is minor damage, or you are unsure about possible damage, ride slowly and cautiously. Sometimes, crash damage is hidden or not immediately apparent, so you should have your motorcycle thoroughly checked at a qualified service facility as soon as possible. Also, be sure to have your dealer check the frame and suspension after any serious crash.

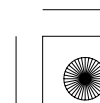
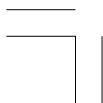

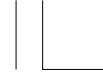

SPECIFICATIONS

DIMENSIONS

Overall length	2,100 mm (82.7 in) ...XR125LK/LEK
	2,065 mm (81.3 in) ...XL125LK
Overall width	820 mm (32.3 in) ...XR125LK/LEK
	827 mm (32.6 in) ...XL125LK
Overall height	1,126 mm (44.3 in) ...XR125LK/LEK
	1,147 mm (45.2 in) ...XL125LK
Wheelbase	1,361 mm (53.6 in) ...XR125LK/LEK
	1,360 mm (53.5 in) ...XL125LK

CAPACITIES

Engine oil	
After draining:	1.0 ℓ (1.1 US qt , 0.9 Imp qt)
After disassembly:	1.2 ℓ (1.3 US qt , 1.1 Imp qt)
Fuel tank	12.0 ℓ (3.17 US gal , 2.64 Imp gal)
Fuel reserve tank	3.2 ℓ (0.85 US gal , 0.70 Imp gal)
Maximum weight capacity	159 kg (351 lb)
Passenger capacity	Operator and one passenger

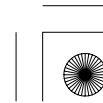
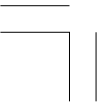



12/04/20 17:13:06 32KRHA20_137



ENGINE

Bore and stroke

52.4 × 57.8 mm (2.06 × 2.28 in)

Compression ratio

9.2 : 1

Displacement

124.7 cm³ (7.61 cu-in)

Spark plug

Standard

CPR7EA-9 (NGK)

For extended high speed riding

CPR8EA-9 (NGK)

Spark plug gap

0.8-0.9 mm (0.03-0.04 in)

Idle speed

1,500 ± 100 min⁻¹ (rpm)

Valve clearance Intake:

0.08 mm (0.003 in)

Exhaust:

0.12 mm (0.005 in)

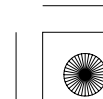



CHASSIS AND SUSPENSION

Caster	27°XR125LK/LEK
	26°54'XL125LK
Trail	104 mm (4.1 in)
Tyre size, front	90/90 – 19M/C 52P
	CHENG SHIN
	C6559FXR125LK/LEK
	70/100 – 21M/C 44P
	CHENG SHIN
Tyre size, rear	CM-704XL125LK
	110/90 – 17M/C 60P
	CHENG SHIN
	C6559XR125LK/LEK
	100/90 – 18M/C 56P
	CHENG SHIN
Tyre type	CM-705XL125LK
	bias-ply, tube



POWER TRANSMISSION

Primary reduction	3.350
Gear ratio, 1st	2.785
2nd	1.875
3rd	1.409
4th	1.120
5th	0.937
Final reduction	3.187

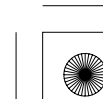
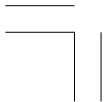



ELECTRICAL

Battery

YTX5L – BS
12V – 4Ah (10HR)...XR125LEK

YTX4L – BS
12V – 3Ah (10HR)...XR125LK, XL125LK
0.12 kW/5,000 min⁻¹ (rpm)

Generator

LIGHTS

Headlight

12V – 35/35W

Brake/Tail light

12V – 21/5W

Turn signal light Front

12V – 16W × 2...XR125LK/LEK

12V – 15W × 2...XL125LK

Rear

12V – 16W × 2...XR125LK/LEK

12V – 15W × 2...XL125LK

Position light

12V – 4W

Licence light

12V – 5W ...XR125LK/LEK

Instrument light

12V – 1.7W

High beam indicator

12V – 3.4W

Turn signal indicator

12V – 3.4W

Neutral indicator

12V – 3.4W

FUSE

Main fuse

15 A

Other fuse

10 A

